

# Beekeeping Basics

MAAREC: Delaware, Maryland, New Jersey, Pennsylvania,  
West Virginia, and the USDA cooperating

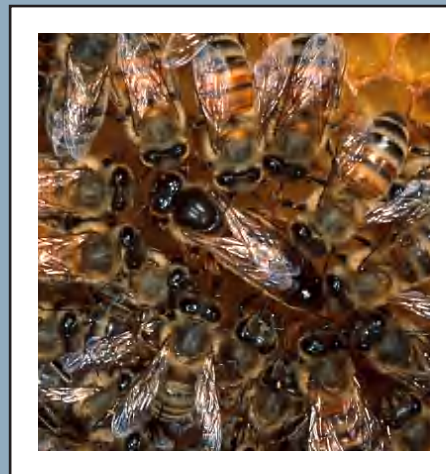

PENNSTATE

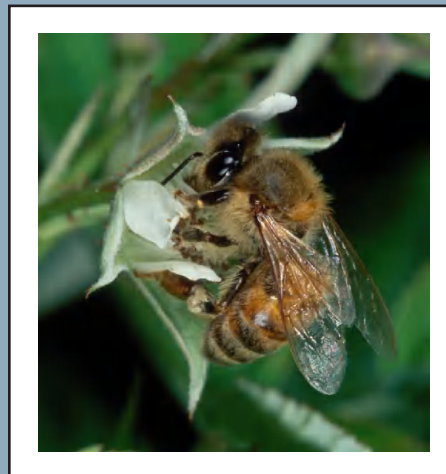

College of Agricultural Sciences  
Cooperative Extension

Hendrick ~~KA~~

# Contents

<b>Introduction</b> .....	<b>2</b>	Diseases of Adult Bees.....	46
<b>The Colony and Its Organization</b> .....	<b>3</b>	Parasitic Mites .....	48
Queen.....	3	Pests.....	54
Drones.....	4	Protecting Honey Bees from Pesticides .....	61
Workers.....	5	<b>Honey Production and Processing</b> .....	<b>62</b>
Laying Workers .....	5	Forms of Honey.....	62
Bee Development .....	5	Honey Removal and Processing .....	66
Brood.....	6	Marketing.....	72
<b>Beekeeping Equipment</b> .....	<b>7</b>	<b>Pollination</b> .....	<b>73</b>
The Hive .....	7	Moving Bees.....	73
Ancillary Equipment .....	11	When to Move Bees on to the Crop.....	74
Protective Clothing .....	12	Colony Strength.....	74
<b>Starting with Bees</b> .....	<b>13</b>	Number of Colonies Needed.....	75
Package Bees.....	13	Competitive Plants.....	75
Nucleus Colonies .....	16	Colony Distribution.....	75
Buying Established Colonies.....	17	Effect of Weather .....	75
Collecting Swarms .....	17	Crop Characteristics and Needs .....	75
Taking Bees out of Walls and Buildings.....	18	Pollination Contracts .....	77
Selecting the Right Type of Bee for Your Operation .....	19	<b>Handling Beeswax and Pollen Trapping</b> .....	<b>78</b>
Apiary Location.....	20	Rendering Beeswax.....	78
Beekeeping in the Urban/Suburban Setting .....	21	Trapping Pollen from Colonies .....	79
Handling Bees.....	23	<b>Floral Sources</b> .....	<b>80</b>
<b>Colony Management</b> .....	<b>25</b>	<b>Glossary</b> .....	<b>82</b>
Early Spring Management of Overwintered Colonies .....	25	<b>Appendix</b> .....	<b>89</b>
Swarm Management.....	27	A. Summary of Current Best Management Practices.....	89
Late Spring and Summer Management.....	30	B. Apiary Inspection and Extension Services in the Mid-Atlantic .....	90
Fall Management.....	31	C. Chemicals Approved for Legal Use in Honey Bee Colonies .....	91
Summary of Management Practices throughout the Year .....	39	D. Sources of Information and Assistance for Beekeepers .....	94
<b>Managing Maladies</b> .....	<b>41</b>	E. Beekeeping Supply Companies.....	98
Diseases, Parasites, and Pests and Their Control.....	41		
Brood Diseases.....	41		

Original guide prepared by Clarence H. Collison, former extension entomologist.

Major updates and revisions prepared by Maryann Frazier, senior extension associate, Penn State, and Dewey Caron, professor of entomology and applied ecology/extension entomologist, University of Delaware.

Contributions made by Ann Harmon and Dennis VanEnglesdorp.

FRONT COVER PHOTOS COURTESY OF MARYANN FRAZIER; BACK COVER PHOTO COURTESY OF STEVE WILLIAMS.



Mid-Atlantic Apiculture  
Research and Extension  
Consortium

## Introduction

Beekeeping can be a fascinating hobby, a profitable sideline, or a full-time occupation. You may want to keep bees for the delicious fresh honey they produce, for the benefits of their valuable services as pollinators, or perhaps simply for the enjoyment of learning more about one of nature's most interesting insects.

Almost anyone can keep bees. Honey bees normally only sting to defend themselves or their colony; when colonies are handled properly and precautions are taken, stinging is not a major problem. Most beekeepers develop a tolerance for bee venom over time and have reduced sensitivity to pain and swelling. However, the few people who react strongly to bee stings and pollen or who are unable to get over fears of stings should avoid contact with bees.

Most beekeepers in the Mid-Atlantic region are hobbyists. Beekeeping is generally considered a minor industry. However, because of its interrelationship with agriculture and dependency of growers of several commodities on honey bee pollination, beekeeping is much more important than merely the value of the beeswax and honey produced annually.

This manual is all about beekeeping—understanding honey bee biology, getting started, managing bee colonies for fun and/or profit—and is designed to help you become a successful beekeeper. Welcome to the world of beekeeping.

Hendric ~~VO~~

## The Colony and Its Organization

Honey bees are social insects, which means that they live together in large, well-organized family groups. Social insects are highly evolved insects that engage in a variety of complex tasks not practiced by the multitude of solitary insects. Communication, complex nest construction, environmental control, defense, and division of the labor are just some of the behaviors that honey bees have developed to exist successfully in social colonies. These fascinating behaviors make social insects in general, and honey bees in particular, among the most fascinating creatures on earth.

A honey bee colony typically consists of three kinds of adult bees: workers, drones, and a queen (Figure 1). Several thousand worker bees cooperate in nest building, food collection, and brood rearing. Each worker has a definite task to perform, related to its adult age. But surviving and reproducing take the combined efforts of the entire colony. Individual bees (workers, drones, and queens) cannot survive without the support of the colony.

In addition to thousands of worker adults, a colony normally has a single queen and several hundred drones during late spring and summer. The social structure of the colony is maintained by the presence of the queen and workers and depends on an effective system of communication. The distribution of chemical pheromones among members and communicative “dances” are responsible for controlling the activities necessary for colony survival. Labor activities among worker bees depend primarily on the age of the bee but vary with the needs of the colony. Reproduction and colony strength depend on the queen, the quantity of food

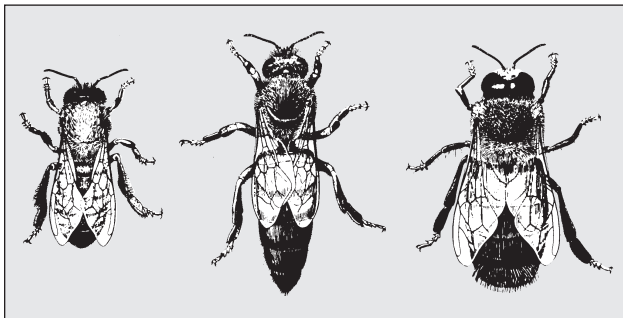

**Figure 1. Three types of honey bees normally found in a honey bee colony: worker, queen, and drone. (Courtesy of the U.S. Department of Agriculture)**

stores, and the size of the worker force. As the size of the colony increases up to a maximum of about 60,000 workers, so does the efficiency of the colony.

### Queen

Each colony has only one queen, except during and a varying period following swarming preparations or supersedure. Because she is the only sexually developed female, her primary function is reproduction. She produces both fertilized and unfertilized eggs. Queens lay the greatest number of eggs in the spring and early summer. During peak production, queens may lay up to 1,500 eggs per day. They gradually cease laying eggs in early October and produce few or no eggs until early next spring (January). One queen may produce up to 250,000 eggs per year and possibly more than a million in her lifetime.

A queen is easily distinguished from other members of the colony. Her body is normally much longer than either the drone’s or worker’s, especially during the egg-laying period when her abdomen is greatly elongated. Her wings cover only about two-thirds of the abdomen, whereas the wings of both workers and drones nearly reach the tip of the abdomen when folded. A queen’s thorax is slightly larger than that of a worker, and she has neither pollen baskets nor functional wax glands. Her stinger is curved and longer than that of the worker, but it has fewer and shorter barbs. The queen can live for several years—sometimes for as long as 5, but average productive life span is 2 to 3 years.

The second major function of a queen is producing pheromones that serve as a social “glue” unifying and helping to give individual identity to a bee colony (Figure 2, next page). One major pheromone—termed queen substance—is produced by her mandibular glands, but others are also important. The characteristics of the colony depend largely on the egg-laying and chemical production capabilities of the queen. Her genetic makeup—along with that of the drones she has mated with—contributes significantly to the quality, size, temperament, and productivity of the colony.

About one week after emerging from a queen cell, the queen leaves the hive to mate with several



**Figure 2. Queen surrounded by attendant workers. Although unique in shape and size, the queen is recognized by workers and drones, not by the way she looks, but by her “chemical signature” or pheromone called queen substance.**

drones in flight. Because she must fly some distance from her colony to mate (nature’s way of avoiding inbreeding), she first circles the hive to orient herself to its location. She leaves the hive by herself and is gone approximately 13 minutes. The queen mates, usually in the afternoon, with seven to fifteen drones at an altitude above 20 feet. Drones are able to find and recognize the queen by her chemical odor (pheromone). If bad weather delays the queen’s mating flight for more than 20 days, she loses the ability to mate and will only be able to lay unfertilized eggs, which result in drones.

After mating, the queen returns to the hive and begins laying eggs in about 48 hours. She releases several sperm from the spermatheca each time she lays an egg destined to become either a worker or queen. If her egg is laid in a larger drone-sized cell, she normally does not release sperm, and the resulting individual becomes a drone. The queen is constantly attended and fed royal jelly by the colony’s worker bees. The number of eggs the queen lays depends on the amount of food she receives and the size of the worker force capable of preparing beeswax cells for her eggs and caring for the larva that will hatch from the eggs in 3 days. When the queen substance secreted by the queen is no longer adequate, the workers prepare to replace (supersede) her. The old queen and her new daughter may both be present in the hive for some time following supersedure.

New (virgin) queens develop from fertilized eggs or from young worker larvae not more than 3 days old. New queens are raised under three different circumstances: emergency, supersedure,

or swarming. When an old queen is accidentally killed, lost, or removed, the worker bees select younger worker larvae to produce emergency queens. These queens are raised in worker cells modified to hang vertically on the comb surface (Figure 3). When an older queen begins to fail (decreased production of queen substance), the colony prepares to raise a new queen. Queens produced as a result of supersedure are usually better than emergency queens since they receive larger quantities of food (royal jelly) during development. Like emergency queen cells, supersedure queen cells typically are raised on the comb surface. In comparison, queen cells produced in preparation for swarming are found along the bottom margins of the frames or in gaps in the beeswax combs within the brood area.

## Drones

Drones (male bees) are the largest bees in the colony. They are generally present only during late spring and summer. The drone’s head is much larger than that of either the queen or worker, and its compound eyes meet at the top of its head. Drones have no stinger, pollen baskets, or wax glands. Their main function is to fertilize the virgin queen during her mating flight, but only a small number of drones perform this function. Drones become sexually mature about a week after emerging and die instantly upon mating. Although drones perform no useful work for the hive, their presence is believed to be important for normal colony functioning.



**Figure 3. Emergency queen cell built by workers by modifying an existing worker cell to accommodate the larger size of the queen. (Courtesy Maryann Frazier)**

While drones normally rely on workers for food, they can feed themselves within the hive after they are 4 days old. Since drones eat three times as much food as workers, an excessive number of drones may place an added stress on the colony's food supply. Drones stay in the hive until they are about 8 days old, after which they begin to take orientation flights. Flight from the hive normally occurs between noon and 4:00 P.M. Drones have never been observed taking food from flowers.

When cold weather begins in the fall and pollen/nectar resources become scarce, drones usually are forced out into the cold and left to starve. Queenless colonies, however, allow them to stay in the hive indefinitely.

### Workers

Workers are the smallest bodied adults and constitute the majority of bees occupying the colony. They are sexually undeveloped females and under normal hive conditions do not lay eggs. Workers have specialized structures, such as brood food glands, scent glands, wax glands, and pollen baskets, which allow them to perform all the labors of the hive. They clean and polish the cells, feed the brood, care for the queen, remove debris, handle incoming nectar, build beeswax combs, guard the entrance, and air-condition and ventilate the hive during their initial few weeks as adults. Later as field bees they forage for nectar, pollen, water, and propolis (plant sap).

The life span of the worker during summer is about 6 weeks. Workers reared in the fall may live as long as 6 months, allowing the colony to survive the winter and assisting in the rearing of new generations in the spring before they die.



**Figure 4.** Eggs laid by workers (laying workers) in a queenless colony. (Courtesy Scott Camazine)

### Laying Workers

When a colony becomes queenless, the ovaries of several workers develop and workers begin to lay unfertilized eggs. Normally, development of the workers' ovaries is inhibited by the presence of brood and the queen and her chemicals. The presence of laying workers in a colony usually means the colony has been queenless for several weeks. However, laying workers also may be found in normal "queenright" colonies during the swarming season and when the colony is headed by a poor queen. Colonies with laying workers are recognized easily: there may be anywhere from five to fifteen eggs per cell (Figure 4) and small-bodied drones are reared in worker-sized cells. In addition, laying workers scatter their eggs more randomly over the brood combs, and eggs can be found on the sides of the cell instead of at the base, where they are placed by a queen. Some of these eggs do not hatch, and many of the drone larvae that do hatch do not survive to maturity in the smaller cells.

### Bee Development

All three types of adult honey bees pass through three developmental stages before emerging as adults: egg, larva, and pupa. The three stages are collectively labeled brood. While the developmental stages are similar, they do differ in duration (see Table 1). Unfertilized eggs become drones, while fertilized eggs become either workers or queens. Nutrition plays an important part in caste development of female bees; larvae destined to become workers receive less royal jelly and more a mixture of honey and pollen compared to the copious amounts of royal jelly that a queen larva receives.

**Table 1.** Developmental stages of the three castes of bees.

DEVELOPMENTAL STAGE	DURATION OF STAGES		
	QUEEN	WORKER	DRONE
	————— Days —————		
Egg	3	3	3
Larval stage	5 ½	6	6 ½
Pupal stage	7 ½	12	14 ½
Total developmental time	16	21	24

## Brood EGGS

Honey bee eggs are normally laid one per cell by the queen. Each egg is attached to the cell bottom and looks like a tiny grain of rice (Figure 5). When first laid, the egg stands straight up on end. However, during the 3-day development period the egg begins to bend over. On the third day, the egg develops into a tiny grub and the larval stage begins.

## LARVAE

Healthy larvae are pearly white in color with a glistening appearance. They are curled in a “C” shape on the bottom of the cell (Figure 6). Worker, queen, and drone cells are capped after larvae are approximately 6, 5½, and 6½ days old, respectively. During the larval stage, they are fed by adult worker (nurse) bees while still inside their beeswax cells. The period just after the cell is capped is called the prepupal stage. During this stage the larva is still grub-like in appearance but stretches itself out lengthwise in the cell and spins a thin silken cocoon. Larvae remain pearly white, plump, and glistening during the prepupal stage.

## PUPAE

Within the individual cells capped with a beeswax cover constructed by adult worker bees, the prepupae begin to change from their larval form to adult bees (Figure 7). Healthy pupae remain white and glistening during the initial stages of development, even though their bodies begin to take on adult forms. Compound eyes are the first feature that begin to take

on color; changing from white to brownish-purple. Soon after this, the rest of the body begins to take on the color of an adult bee. New workers, queens, and drones emerge approximately 12, 7½, and 14½ days, respectively, after their cells are capped.

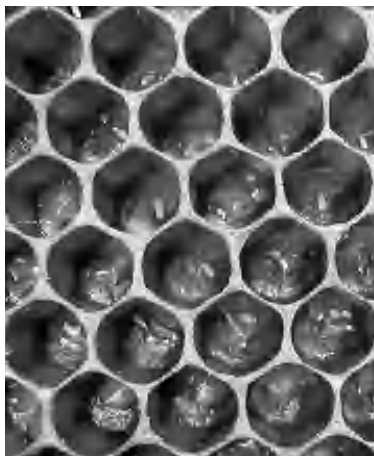

**Figure 5.** Cells with fertilized eggs laid by the queen. (Courtesy Maryann Frazier)

## BROOD PATTERNS

Healthy brood patterns are easily recognized when looking at capped brood. Frames of healthy capped worker brood normally have a solid pattern with few cells missed by the queen in her egg laying. Cappings are medium brown in color, convex, and without punctures (Figure 8). Because of developmental time, the ratio should be four times as many pupae as eggs and twice as many as larvae; drone brood is usually in patches around the margins of brood nest.

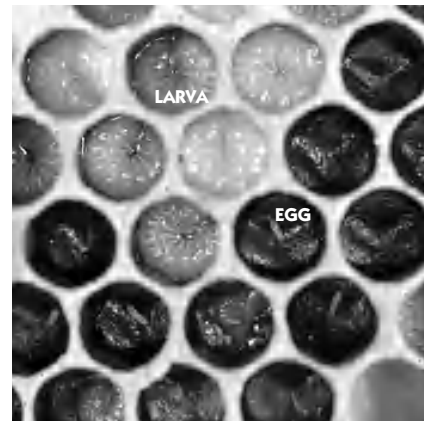

**Figure 6.** Cells with healthy worker larvae. (Courtesy Dewey Caron)



**Figure 7.** Honey bee pupae changing from the larval to adult form. (Courtesy Scott Camazine)

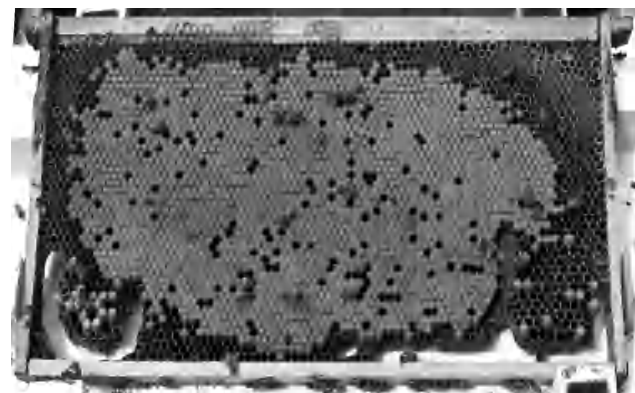

**Figure 8.** Comb of sealed worker brood with drone cells in the lower corners. (Courtesy Maryann Frazier)



# Beekeeping Equipment

Equipment needs vary with the size of your operation, number of colonies, and the type of honey you plan to produce. The basic equipment you need are the components of the hive, protective gear, smoker and hive tool, and the equipment you need for handling the honey crop.

The hive is the man-made structure in which the honey bee colony lives. Over the years a wide variety of hives have been developed. Today most beekeepers in the United States use the Langstroth or modern ten-frame hive. A typical hive consists of a hive stand, a bottom board with entrance cleat or reducer, a series of boxes or hive bodies with suspended frames containing foundation or comb, and inner and outer covers (Figure 9, next page, includes dimensions for those wishing to construct their own hives). The hive bodies that contain the brood nest may be separated from the honey supers (where the surplus honey is stored) with a queen excluder.

## The Hive

### HIVE STAND

The hive stand, actually an optional piece of equipment, elevates the bottom board (floor) of the hive off the ground. In principle, this support reduces dampness in the hive, extends the life of the bottom board, and helps keep the front entrance free of grass and weeds. Hive stands may be concrete blocks, bricks, railroad ties, pallets, logs, or a commercially produced hive stand. A hive stand may support a single colony, two colonies, or a row of several colonies.

### BOTTOM BOARD

The bottom board serves as the floor of the colony and as a takeoff and landing platform for foraging bees. Since the bottom board is open in the front, the colony should be tilted forward slightly to prevent rainwater from running into the hive. Bottom boards available from many bee supply dealers are reversible, providing either a  $\frac{7}{8}$ - or  $\frac{3}{8}$ -inch opening in front.

### HIVE BODIES

The standard ten-frame hive body is available in four common depths or heights. The full-depth hive body,  $9\frac{5}{8}$  inches high, is most often used for brood rearing. These large units provide adequate space with minimum interruption for large solid brood areas. They also are suitable for honey supers. However, when filled with honey, they weigh over 60 pounds and are heavy to handle.

The medium-depth super, sometimes called the Dadant or Illinois super, is  $6\frac{5}{8}$  inches high. While this is the most convenient size for honey supers, it cannot be cut efficiently from standard-sized lumber. An intermediate size ( $7\frac{5}{8}$  inches) between the full- and medium-depth super is preferred by some beekeepers, especially those who make their own boxes.

The shallow-depth super,  $5\frac{1}{16}$  inches high, is the lightest unit to manipulate (about 35 pounds when filled with honey). This size has the greatest cost of assembly per square inch of usable comb space.

Section comb honey supers,  $4\frac{5}{8}$  inches high, hold either basswood section boxes or plastic rings and section holders. Section comb honey production is a specialized art requiring intense management and generally is not recommended for beginners.

Some beekeepers prefer eight-frame hive bodies. These were mostly homemade, but one U.S. bee supplier is now selling eight-frame boxes as English garden hive boxes. Beekeepers rearing queens and/or selling small starter colonies (nucs) prefer to use a three- or five-frame nuc box usually with standard deep frames. These can be purchased from bee supply dealers and are constructed from wood or cardboard, the latter for temporary use only.

Different management schemes are used according to the depth of hive bodies utilized for the brood area of the hive. One scheme is to use a single full-depth hive body, which theoretically would give the queen all the room she needs for egg laying. However, additional space is needed for food storage and maximum brood nest expansion. Normally a single full-depth brood chamber is used when beekeepers want to crowd bees for comb honey production, when a package is installed, or when a nucleus colony or division is first established. Most beekeepers elect to use either two full-depth hive bodies or a

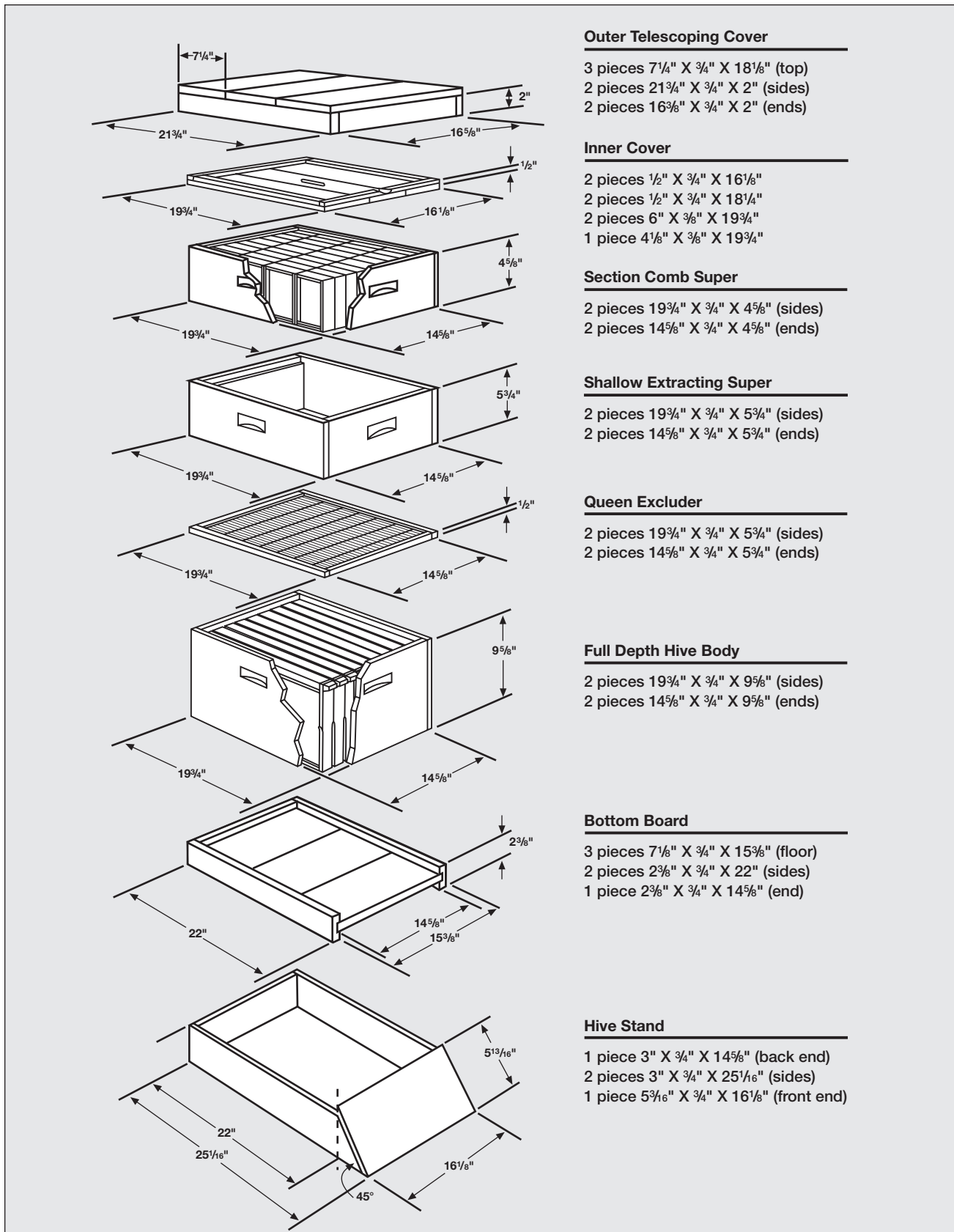

ILLUSTRATION BY PETER KAUFFMAN

Figure 9. Equipment and dimensions for a standard Langstroth hive.



**Figure 10. Typical honey bee colonies with two hive bodies and one super (front two colonies). The colony on the left is on a hive scale. (Courtesy Dewey Caron)**

full-depth and a medium or shallow for the brood area (Figure 10). However, using hive bodies similar in size permits the interchange of combs between the two hive bodies. Beekeepers who wish to avoid heavy full-depth hive bodies may elect to use three shallow hive bodies for the brood nest. This approach is certainly satisfactory, but it is also the most expensive and time consuming in assembly since it requires three boxes and thirty frames instead of two boxes and twenty frames.

### FRAMES AND COMBS

The suspended beeswax comb held within a frame is the basic structural component inside the hive. In a man-made hive, the wooden or plastic beeswax comb is started from a sheet of beeswax or plastic foundation. After the workers have added wax to draw out the foundation, the drawn cells are used for storage of honey and pollen or used for brood rearing.

Frames are  $17\frac{5}{8}$  inches long and either  $9\frac{1}{8}$ ,  $7\frac{1}{4}$ ,  $6\frac{1}{4}$ , or  $5\frac{3}{8}$  inches high to fit the various hive-body depths. Each frame consists of a top bar, two end bars, and a bottom bar. Top bars may be either grooved or wedged; bottom bars are split, solid, or grooved. Some types may have advantages over others, but the choice is generally a personal preference that includes consideration of cost. Top bars are suspended on ledges or rabbets in the ends of the hive body. V-shaped metal strips or metal frame spacers are often nailed on the recess for reinforcement. A popular commercial end bar has shoulders to help ensure correct bee space between adjacent frames and side of the box.

The comb foundation consists of thin sheets of beeswax imprinted on each side with patterns of worker-sized cells (Figure 11). Two basic types of comb foundations are distinguished by their relative thickness: thin surplus foundation is used to produce section comb honey, chunk honey, or cut-comb honey; a thicker, heavier foundation should be used in the brood chamber and in frames for producing extracted honey. Thicker foundations often are reinforced with vertically embedded wires, thin sheets of plastic, metal edges, or nylon threads. When deciding whether to invest in plastic beeswax foundation in plastic frames versus pure beeswax foundation in wooden or plastic frames, initial cost, assembly time, durability, and length of expected use are all factors you should consider. Plastic foundation and frames are becoming increasingly popular.

When using beeswax foundation in wooden frames, securing the foundation within the frame with either metal support pins or horizontal wires is necessary. The thin wedge of the top bar secures wire hooks extending from one side of the vertically wired foundation to help secure the foundation, ensuring that it remains in the center of the frame for proper drawing by the bees. Combs may be strengthened further by embedding horizontal wires (28 or 30 gauge) into the foundation with an electric current from a small transformer or by using a spur wire embedder. This activity is time consuming and difficult to master, but only a well-supported foundation results in well-drawn combs.



**Figure 11. A sheet of comb foundation suspended in a wooden frame. (Courtesy Dewey Caron)**

Frames with new foundation should only be given to rapidly growing colonies such as a package, swarm, or colony split (division) or to established colonies during a major nectar flow. Workers build beeswax combs of six-sided cells by adding wax to the cell base imprints on the sheet of foundation. When foundation is given to colonies during a nectar dearth, the bees will often chew holes in the foundation, thus resulting in poorly drawn finished combs.

Beeswax is produced by four pairs of glands on the underside of the worker's abdomen. As wax is secreted and exposed to the air, it hardens into flat wax scales. To produce comb, the bees remove the wax scales from the underside of the abdomen with spines located on their middle legs. The wax scale is then passed to the mouthparts where it is manipulated until pliable and ready to be formed into six-sided cells.

### **QUEEN EXCLUDER**

The primary functions of the queen excluder are to confine the queen and her brood and to store pollen in the brood nest. It is an optional piece of equipment and is used by less than 50 percent of beekeepers. Many beekeepers refer to queen excluders as "honey excluders" because at times workers are reluctant to pass through the narrow openings of the excluder to store nectar in the supers above until all available space in the brood chambers is used up. To minimize this problem, allow the bees to begin storing nectar in the supers before installing the excluder. Nectar stored in drawn comb will entice the bees to pass through the excluder. Never put supers of foundation above a queen excluder.

An excluder is constructed of a thin sheet of perforated metal or plastic with openings large enough for workers to pass through. Other designs consist of welded round-wire grills supported by wooden or metal frames.

Frames of honey in the super directly above the brood chamber or comb sections act as a natural barrier to keep the queen confined to the brood nest. Properly timing the reversal of brood chambers in the spring with supering during a surplus nectar flow will serve the same purpose as a queen excluder. For this reason, queen excluders are sometimes used with the addition of the first supers (but again, installed only after some nectar has been stored in the supers)

and then removed. Since beeswax combs used for brood darken with use, a queen excluder can help ensure separation of brood combs from honey combs to avoid unnecessarily darkening honey.

Queen excluders also are used to separate queens in a two-queen system, to raise queens in queenright colonies, and for emergency swarm prevention. An excluder also may help in finding the queen. If you place an excluder between two hive bodies, after 3 days you will be able to determine which hive body contains the queen by locating where eggs are present.

### **INNER COVER**

The inner cover rests on top of the uppermost super and beneath the outer telescoping cover. It prevents the bees from gluing down the outer cover to the super with propolis and wax. It also provides an air space just under the outer cover for insulation. During summer, the inner cover protects the interior of the hive from the direct rays of the sun. During winter, it prevents moisture-laden air from directly contacting cold surfaces. The center hole in the inner cover may be fitted with a Porter bee escape to aid in removing bees from full supers of honey.

### **OUTER COVER**

An outer telescoping cover protects hive parts from the weather. It fits over the inner cover and the top edge of the uppermost hive body. The top is normally covered with a sheet of metal to prevent weathering and leaking. Removal of the outer cover, with the inner cover in place, disturbs few bees within the hive and allows the beekeeper to more easily smoke the bees prior to colony manipulation.

Beekeepers that routinely move hives use a simple cover, often referred to as a migratory lid. Covers of this type fit flush with the sides of the hive body and may or may not extend over the ends. In addition to being lightweight and easy to remove, these covers allow colonies to be stacked. Tight stacking is important in securing a load of hives on a truck.

### **OTHER PIECES OF HIVE EQUIPMENT**

In addition to the basic hive components, adding other pieces of equipment is possible. A few beekeepers like to use the slatted bottom board, others a different English-style cover. Beekeeping offers much room for creativity and individualization.

### **PLASTIC HIVE EQUIPMENT**

The basic parts of the hive traditionally have been made out of pine, cypress, or redwood. Today all hive components are available in plastic. Plastic hive components and plastic frames that snap together are durable, strong, lightweight, easy to assemble, and require little maintenance. While plastic frames and foundation are becoming increasingly popular, plastic hive covers, bottom boards, and hive bodies have not proved to be as useful because plastic does not breathe and does not allow easy moisture ventilation. Plastic also warps easily, and some types let in too much light, which makes drawing foundation difficult.

### **PAINTING THE HIVE PARTS**

All parts of the hive exposed to the weather should be protected with paint. Do not paint the inside of the hive; the bees will varnish it with propolis (a mix of plant sap and wax). The only purpose in painting is to preserve the wood. Most beekeepers use a good latex or oil-based, exterior, white paint. A light color is desirable because it prevents heat buildup in the hive during summer. Although white is a traditional color, various combinations of colors will help reduce drift between colonies.

### **SUPPLIERS**

New bee equipment is generally “knocked down” or unassembled when purchased, but you can also purchase assembled equipment for a higher price and shipping fee. Assembly directions are furnished by bee supply dealers and are usually easy to follow. Novice beekeepers are strongly encouraged to seek the help of a more experienced beekeeper in assembling the hive components for the first time. Beginners should purchase their equipment early so that they can put together and paint hives before the bees arrive. Sheets of foundations should not be installed in the frames until needed because storage temperatures and handling may cause the wax to stretch and warp, resulting in poorly drawn combs.

Some beekeepers find they can save money by making their own equipment or by purchasing used equipment. With both approaches, the equipment must be a standard size. When constructing beekeeping equipment, a thorough understanding of bee space is a necessity. You can consult readily available construction plans, such as those supplied on page 8, or use commercial pieces as a pattern. Many beekeepers find they can economically make covers, hive bodies, and bottom boards, but frames are more difficult and time consuming. Success depends on availability and cost of materials, proper woodworking equipment, and the beekeeper’s woodworking skills.

Purchasing used equipment can present problems and is not recommended for the beginner. Initially you may have problems simply locating a source of used equipment and determining its value or worth. In addition, secondhand equipment may be of non-standard dimensions or contaminated with pathogens that cause various bee diseases, despite considerable time in storage. Always ask for an inspection certificate indicating that the state apiary inspector examined the hives and did not find any evidence of disease.

For additional information and sources on beekeeping equipment and supplies, see the list of dealers in the appendix or consult local and regional beekeeping newsletters, your local county extension office, national and regional beekeeping publications, or the MAAREC Web site ([maarec.cas.psu.edu](http://maarec.cas.psu.edu)).

---

## **Ancillary Equipment**

### **SMOKER**

A bee smoker and hive tool are essential for working bees. The smoker consists of a metal fire pot and grate with bellows attached. The size of the smoker is a matter of individual preference. The 4 x 7 inch size is probably the most widely used. Plan to purchase/use a smoker with a heat shield around the firebox to avoid burning clothing or yourself if you intend to support the smoker between your legs as you work a colony. Some beekeepers like the model with a hook to hang the smoker over the open hive body as they inspect it, thus keeping the smoker handy at all times.

To produce large quantities of cool, thick smoke, coals must be above the grate and unburned materials must be above the coals. Suitable smoker fuels

include burlap, corn cobs, wood shavings, pine needles, cardboard, punk wood, bark, sumac bobs, cotton rags, dry leaves, and bailer twine. An alternative liquid smoke is available that you mix with water and spray onto the bees with a mister-type applicator.

### HIVE TOOL

The hive tool is a metal bar essential for prying apart frames in a brood chamber or honey super, separating hive bodies, and scraping away wax and propolis (Figure 12). Holsters to hold hive tools are available, but many beekeepers prefer to hold the hive tool in the palm of their hand to keep it accessible and to keep their fingers free for lifting boxes and frames. The hive tool should be cleaned from time to time to remove propolis, wax, and honey. This may be done simply by stabbing the tool into the ground or by burning it in the hot fire pot of a smoker. Both cleaning methods help prevent the spread of bee diseases. A screwdriver or a putty knife are poor substitutes for a sturdy hive tool and may cause frame/hive body damage.



**Figure 12.** A hive tool being used to remove burr comb from the top bars on the comb. (Courtesy Dewey Caron)

## Protective Clothing

You should wear a bee veil at all times to protect your face and neck from stings. Three basic types of veils are available: those that are open at the top to fit over a hat, completely hatless veils, and veils that form part of a bee suit. A wire or fabric veil that stands out away from the face worn over a wide-brim, lightweight hat that fits securely offers the best protection. Veils without hats, although lightweight and fold easily for transport, do not always fit as securely on the head as they should. The elastic band that fits around your head often works upward, allowing the veil to fall against your face and scalp as you bend over to work with bees.

A wide variety of coveralls (bee suits) is available to beekeepers in a wide price range. The most expensive bee suits are not always the best or easiest to use. Coveralls are useful to avoid getting propolis on your clothing and greatly reduce stings if maintained properly and laundered regularly. Coveralls or shirtveils (long-sleeved shirts) made especially for beekeepers with attached, removable veils are popular.

White or tan clothing is most suitable when working bees. Other colors are acceptable, but bees react unfavorably to dark colors, fuzzy materials, and clothing made from animal fiber. Windbreakers and coveralls made from ripstop nylon fabric are excellent for working bees, although they may be too hot to use in the summer.

Beginners who fear being stung should wear canvas or leather gloves. Many experienced beekeepers find gloves cumbersome and decide to risk a few stings for the sake of easier handling. Form-fitting gloves (such as those suitable for lab work or household chores) reduce stings and sticky fingers from honey and propolis. Ankles with dark socks and open wrists are areas vulnerable to stings. Angry bees often attack ankles first because they are at the level of the hive entrance. You should secure your pant legs with string or rubber bands or tuck them inside your shoes or socks. Secure open shirtsleeves with Velcro, rubber bands, or wristlets to reduce stings to these sensitive areas.

You should avoid using after-shave lotions, perfumes, and colognes when working with bees because such odors may attract curious bees. Regularly launder clothing and gloves used in inspection to eliminate sting/hive odors that might attract/irritate bees.

## Starting with Bees

There are several different ways of getting started in beekeeping: buying package bees; purchasing a nucleus (nuc) colony; buying established colonies; collecting swarms; and taking bees out of tree and/or wall cavities. We recommend novices start with either a package(s) or nucleus colony(ies). However, you should be careful when purchasing nucs (and established colonies) because you might be buying other beekeepers' problems such as disease or non-standard equipment. Collecting swarms and transferring bees is more difficult and not recommended for the beginner without the assistance of a more experienced beekeeper. The best time to start with bees is in the spring or early summer.

### Package Bees

Package bees are produced in the southern states and California for shipping to northern beekeepers who wish to strengthen weak colonies or establish new colonies in the spring. Packages are available in 2-, 3-, or 5-pound sizes (Figure 13). The most popular packages are the 2- and 3-pound sizes. Each pound represents about 3,500 bees. A newly mated queen is included to be used for developing new colonies. Packages intended for strengthening weak colonies may be ordered with or without a queen.



**Figure 13.** Three-pound packages ready to be installed into hives. (Courtesy Maryann Frazier)

You should order packages in January or February to ensure timely delivery in early spring (April). If you are installing packages on drawn combs containing honey and pollen, you can do so in early April; if you are installing them on comb foundation, then you should have them arrive in late April or early May. Beekeepers in northern areas may wish to delay shipments for a couple of weeks. Package bees could die if installed on foundation in temperatures below 57°F (14°C) because too few bees will be able to break cluster and move to syrup feeders. Bees clustered on combs of honey, on the other hand, do not have to break cluster in order to eat.

Standard wooden shipping cages measure about 6 x 10 x 16 inches with wire screen on the long sides for ventilation. A can containing a food supply of 50 percent sugar syrup is positioned in the middle of the cage. A few small holes in the bottom of the can allow the bees to withdraw the syrup. A young mated queen is housed in a separate cage that is suspended at the top of the package next to the feeder can. Two or three worker bees (attendants) commonly are caged with the queen to care for her. Queen cages usually are supplied with a food source of sugar candy. A mite treatment strip may also be suspended from the top of the cage or stapled to the back of the queen cage. Packages are braced several inches apart to protect them from crowding and overheating during shipment (Figure 13).

You can obtain packages from a local beekeeper or supply dealer who has purchased them in bulk from a reputable package producer, or you can order them directly from the producer and have them shipped by U.S. mail. You should alert officials at the post office about the expected date of arrival and should request immediate notification.

Upon arrival, you should inspect package bees for unusual numbers of dead bees. Some bee mortality is normal, but when dead bees accumulate more than a ½ inch in the bottom of the shipping cage or when queens are dead on arrival, you should file a damage claim with the postal clerk immediately, noting the condition of the package. You should then send this statement to the package producer so that losses may be replaced.

Package bees are perishable, so handle them with care. Before installing, protect them from wind and cold but do not put them in a heated area. If packages arrive when the temperature is below 45°F (18°C) and are to be transported in an open truck, cover them with burlap or paper while in transit. If transported in a closed truck or car, no extra protection is needed.

You should try to install packages as soon as possible after their arrival, although you can delay installation for up to 48 hours with little difficulty. Feed the bees as soon as you get them and continue feeding until they are installed. Spray or sprinkle the cage screen with 50 percent sugar syrup, preferably in a room where the temperature is around 70°F (21°C). Avoid brushing the syrup onto the screen, as this may injure the bees' mouthparts. After feeding the bees, store them in a cool, dry, and preferably dark place, such as a basement, porch, or garage. Storage temperature should be between 50° (10°C) and 60°F (15°C). The bees will recluster around their queen and become quiet. Package bees soon die if they are stored where the temperature is above 80°F (26°C) or if they are left standing in the sun.



**Figure 14.** A full-depth hive body with middle frames removed to receive a package of bees. Sugar syrup feeder and queen cage are removed from the package before shaking the bees from the package into the empty space. (Courtesy Dewey Caron)

Before the packages arrive, the hives to be used should be assembled, in place, and ready to receive them. Ideally, package bees should be installed in late afternoon or early evening, when there is little opportunity for flight. On cool days, package bees may be put into hives at any time. If the bees are well fed, they are much easier to install.

Start your installation by opening the empty hive and removing five or six middle frames. Insert an entrance reducer to provide the smallest hive opening. Then close the entrance completely by placing some green grass in the small opening. This will keep the bees in the hive until they settle down. The temporary grass entrance plug can be removed after installation is completed.

Now with your hive ready to receive the package bees, remove the square piece of wood that covers the top, the feeder can, and the queen cage (Figure 14). Check to make sure the queen is alive. Remove the cork or any other covering from the candy end of the queen cage and make a small hole through the candy using either a nail or toothpick-sized twig (Figure 15). Take care that you do not injure the queen. The hole should be small enough to prevent the bees from coming out immediately, but large enough so the bees can release their queen in 24 to 48 hours.

There are several different ways to install or transfer the bees from the mailing cage to the hive.



**Figure 15.** Remove the cork over the candy end of the queen cage and make a small hole through the sugar candy with a 6p nail or toothpick. (Courtesy Maryann Frazier)



One method is to place the mailing cage in the open space left after removing the middle frames, allowing the bees to exit by themselves. The first step in this type of installation is to wedge the queen cage between the top bars of the two combs (Figure 16) next to the mailing cage. Place the queen cage with the candy end up, so dead worker bees within the cage do not block the exit hole. Bees should have maximum access to the screen face of the queen's cage so that they can feed her and receive her chemical pheromones. Shake about a handful or two of bees around the queen cage to expedite movement of the bees from the package to the combs. During cool weather, shake more bees on the queen cage to prevent the queen from becoming chilled. Then place the package in the open space and close the hive. Return to the hive in 4 or 5 days to remove the empty mailing and queen cages and replace the frames.



**Figure 16. The queen cage, sugar candy end upward, is wedged between two frames. (Courtesy Maryann Frazier)**

A better way to install packages is by shaking. Prepare the hive as described previously. Just before opening the package, sprinkle both sides of the screened shipping cage with sugar syrup so the bees' wings become wet. Knock the bees to the bottom of the cage by jarring a corner of the package against the ground or hive. As you remove the feeder can, sprinkle the bees through the top opening. (Do not overdo the sprinkling in cool weather.) Remove the queen cage, inspect the queen, and place the cage aside but not in direct sunlight. Gently shake the bees out of the package into the open space left by the removal of the middle frames (Figure 17). While the bees will fall out fairly readily, you still should jar the package against the ground



**Figure 17. Gently shake the bees from the package into the hive. Note shipping feeder can at front right. (Courtesy Maryann Frazier)**

two or three times, collecting any remaining bees in one corner of the package before reshaking remaining bees into the hive. If the bees' wings are damp with syrup, there will be little flying. Leave the mailing cage beside the entrance, touching the bottom board overnight so any remaining bees can escape. With the hive tool, gently level the pile of bees on the bottom board. You can position the queen cage, with cork removed from the candy end, between two frames as previously described (Figure 16). An alternative is to directly release the queen. To direct release a queen, first sprinkle a little syrup on the queen through the queen cage screen. Next, lower the queen cage into the hive close to one of the exposed combs. Remove the screen with your hive tool and let the queen crawl onto the comb or among the bees. Carefully replace the previously removed combs to avoid injuring the bees and the queen. Replace the inner and outer covers

### **FEEDING PACKAGES SYRUP**

One of the most important considerations in developing a strong colony from a package is to supply plenty of food until a strong nectar flow begins. Unless you install your packages on drawn combs containing sufficient honey and pollen (taken from existing colonies or from storage), you should plan to feed the bees immediately upon installation and continue feeding them until they are able to fend for

themselves. This is critically important when installing packages on foundation.

There are several efficient ways of feeding sugar syrup to your colonies. One of the easiest methods of getting food to colonies hived from packages is to invert a feeder can or plastic jar over the hole in the inner cover. You can make this feeder by punching ten to fifteen small nail holes in the lid of a jar or can with removable lid (such as coffee can or clean paint can). Do not leave the hive top and feeder can exposed—place an empty hive body on top of the hive body with the bees to enclose the feeder and replace the outer cover (see “Feeding Honey Bees” in the next section for more information on feeding). Leave the hive alone for at least 4 to 5 days, except to refill the feeder as needed. After 7 to 9 days, examine the hive briefly to see if the queen is accepted and laying. Use smoke sparingly during this inspection, and handle the bees and equipment gently. If either the shipping or queen cage remain in the colony, you should remove these at this time. Check a frame or two for eggs and larvae. If you find a colony without a queen (no eggs or larvae and no visible sign of the queen) you should give it another queen without delay to avoid losing the entire colony. If obtaining a new queen immediately is impossible, the only practical recourse is to combine it with a queenright package or colony.

You can also install package bees in a hive body above a double screen placed on top of an established strong colony. The warmth of the established colony on the bottom improves the development of the new colony. Hive the package by shaking the bees from the shipping container and direct release the queen (as described previously). You need to provide an entrance to the rear of the hive for the new colony and feed it sugar syrup as you would other hives established from packages.

During the first 21 days after installation, a package bee colony experiences about a 35 percent loss in population. This loss occurs because new adult workers require 21 days to develop, during which time the older bees of the existing population die. After this period, the rate of emergence of young workers begins to exceed the rate of death of older bees and the population grows. About 4 weeks after installation the population is completely restored. Some beekeepers compensate for the initial shrinkage in package bee colony size by giving each package a frame or two of capped brood from an

established colony. The capped brood helps increase the population of young bees and stimulates growth of the colony. Likewise, beekeepers with colonies that have sufficient capped honey frames provide packages with one or two drawn frames containing honey to stimulate more rapid package development. The major disadvantage when giving package bees brood and honey is the possibility of spreading disease/mites to the new colony.

Newly hived package bees are very susceptible to nosema disease, which often leads to queen supersedure or queenlessness. Feeding fumagillin medicated syrup to newly installed packages is highly recommended (see “Nosema” in the section “Managing Maladies”).

About 1½ to 2 months after installation, when the package bee colony requires additional space, you should place another hive body of frames on top of the brood chamber, either as a super for surplus honey or for brood chamber expansion.

---

## Nucleus Colonies

A nucleus colony, or nuc, is essentially a smaller hive, sometimes in a smaller box, consisting of bees in all stages of development, as well as food, a laying queen, and enough workers to cover from three to five combs (Figure 18). When placed into a full-sized hive body and given supplemental feeding, the nuc usually expands rapidly into a



**Figure 18.** A beekeeper inspecting a nucleus colony housed in a cardboard box for sale and transport. (Courtesy Maryann Frazier)

strong colony. When started in early spring, these hives may produce surplus honey in their first year under favorable weather and nectar flow conditions. The advantages of starting with a nuc rather than a package include faster colony development due to the presence of brood and no break in the queen's laying cycle; ease of establishing the unit in your own equipment; and a chance to inspect the nuc before purchasing. Sales of nucs have increased tremendously over the past few years and are making inroads into the well-established package bee businesses.

While nucleus colonies are initially more expensive than packages, their potential financial returns at season's end more than make up for the increased purchase price. The biggest disadvantage in purchasing a nuc is the potential of disease and/or mite transmission. Inspection and certification of nucs for sale is not required and depending on how they were handled before sale, disease may occur among some nucleus colonies after they are purchased. Bees that are diseased and have been fed antibiotic drugs may appear healthy, but the combs will be contaminated with disease-causing organisms. If the buyer does not continue the drug feeding program, it will be only a matter of time until the disease reappears (see "American foulbrood"). You should only purchase nucs from reputable beekeepers. Check with your local or state beekeeping association to identify beekeepers that have a good reputation for producing high-quality, disease-free nucs.

The strength of nucs varies a great deal from source to source based partly on number of frames, bee stock, and environmental conditions during the time the nuc was made up. Population differences may also be due to how long the nuc has been made up and/or the lack of well-defined guidelines for making up nucs. One beekeeper may provide one frame of brood in a five-frame nuc box, while another will provide three. Before purchasing nucs, be sure price reflects the strength of the nucleus colonies.

---

## Buying Established Colonies

Purchasing established colonies is not recommended for beginners, but experienced beekeepers may find this a practical means to increase their number of colonies. Problems associated with buying used equipment and bees include determining the true

market value, the potential of acquiring disease, and getting equipment that is highly variable in condition and possibly not of standard dimensions.

While financial returns from an established colony can be realized in the first season, beginners usually are not adequately experienced to manage a full-strength colony. Purchasing smaller units such as packages or nucs in the spring allows a beginner to grow in confidence and managerial skills as the colony size increases during the season.

---

## Collecting Swarms

Collecting honey bee swarms in the spring is an excellent way to replace winter losses, strengthen weak colonies, or start new ones. Primary swarms are valuable; they may contain as many as 25,000 bees plus the queen. In comparison, a 3-pound package will number approximately 10,500 bees. Three considerations to keep in mind before attempting to collect a swarm are (1) how long the swarm has been there, (2) where the swarm is located, and (3) its size.

Swarms normally cluster on a tree limb (Figure 19), shrub, fence post, or on the side of a building. When possible, remove the swarm gently, disturbing the cluster as little as possible, and put it directly into a hive or enclosed container (a cardboard box with a tight-fitting lid works well) to transport it to a new hive or location. If the swarm cannot be cut down, either shake or scrape the bees into a lightweight box



**Figure 19.**  
A typical honey  
bee swarm.  
(Courtesy  
Maryann Frazier)



**Figure 20.** To collect a swarm hanging from a tree limb, shake the limb with a quick, sharp snap of the wrist two or three times so that the cluster falls into the box. (Courtesy Maryann Frazier)



**Figure 21.** Swarms collected in light-weight box with a tight-fitting lid are easy to transport back to the apiary. (Courtesy Maryann Frazier)

(Figures 20 and 21). When a swarm settles in a very high tree or on any other inaccessible structure, it is best to leave it there. Such swarms may be an after-swarm with one or more virgin queens and their successful capture can be very difficult. Sometimes you can knock these high swarms into a bucket at the end of a long pole and then lower it to a collecting box. The success rate, however, is very low.

Once you have successfully captured a swarm, you can introduce the swarm into your own equipment by either shaking or dumping the bees into an open hive with several frames removed or simply by shaking it in front of the hive (Figure 22). If you were successful in getting the queen with the rest of the swarm, the bees will adopt the hive. Using drawn combs is better than foundation when introducing swarms to an empty hive, but one or two drawn combs, preferably with pollen, brood, and/or honey (from a disease-free colony), combined with foundation also works.

Instead of waiting for swarms to simply appear, you can try baiting swarms. Pheromone lures (available from beekeeping supply companies) placed in special light-weight bait hives or empty hive bodies (with or without drawn comb) can be used to lure swarms. Place trap boxes in exposed locations 8–15 feet off the ground (with entrance reduced to keep birds and squirrels out) and check weekly during the swarm season (April–June, depending on your location) so you can transfer any swarms into a standard hive in a timely fashion.

### Taking Bees out of Walls and Buildings

Honey bee colonies and their combs can be transferred from a tree or wall into a hive. Because of the amount of work involved and the difficulty of obtaining good combs, you should not consider this method a convenient or easy way of obtaining bees unless you have no other alternative. In many situations, the beekeeper is providing a service for homeowners and should charge for it.

The best way of removing a colony from a wall is to remove the siding or other exterior coverings to completely expose the colony. Then cut out the combs and brush or vacuum the bees from the interior of the wall. If exposing the colony is impossible, you may try to trap the majority of the bees out of the tree or wall. The first step in trapping bees



**Figure 22.** Swarm of honey bees that has been shaken in front of the hive. (Courtesy Maryann Frazier)

is to close up all flight holes except one. Place a cone of window screen about 6 inches long, with an opening  $\frac{1}{4}$  inch to  $\frac{3}{8}$  inch in diameter at the apex over the open flight hole. Near the flight hole place a weak hive consisting of two or three frames of brood and bees with a queen or queen cell. In principle, the bees from the colony in the wall can leave freely through the screen cone but cannot return to the old nest, so they will enter the new hive prepared for them. It will take about a month for the brood in the old combs to hatch. By this time, most of the bees will be in the new hive. Keep in mind that completely trapping all of the bees or the queen is impossible.

After most activity from the old hive has ceased, remove the screen cone and leave the new hive in position for a week or longer. If no honey flow is in progress, the bees from the strong hive will rob out the old combs in the wall or tree. After the robbing has ceased, seal off the entrance to the old nest so that future swarms cannot establish themselves in the same location.

Remove the hive on the platform in the evening when all the bees are inside. To avoid the possibility of the hive bees returning to their original location, move the hive at least 3 miles away.

---

## Selecting the Right Type of Bee for Your Operation

New beekeepers face the sometimes difficult decision of which strain or race of bee to order, and from whom to order them, when obtaining packages and queens.

Honey bees in the United States are a heterogeneous blend of several races introduced from Europe, the Middle East, and Africa. Currently, there are three major races: Italians, Caucasians, and Carniolans. However, those now present in the United States are not the same as the original races they were named after. Many strains of the original races and a couple of hybrids have been developed through interbreeding and selection.

To determine which race or strain of bees would best suit your operation, first consider the advantages and disadvantages of each. Over time you may want to try queens and packages from different queen breeders and suppliers to learn more about the behavior and productivity of each strain under your local conditions.

Italian bees are the most popular race in the United States. First introduced in 1859, they basically replaced the original black or German bee brought over by early colonists. The Italian bee is light yellowish or brown with alternating stripes of brown and black on the abdomen. Those with three abdominal bands (workers) are sometimes called leather-colored Italians; those with five bands are sometimes called goldens or cordovan queens. Italian bees tend to start brood rearing early in the spring and continue until late fall, which results in a large population throughout the active season. Large colonies can collect a considerable amount of nectar in a relatively short period, but they also require more honey for maintenance during the fall/winter than do the dark races. Most strains of Italian bees are considered to be quiet and gentle on the combs. Disadvantages include weaker orientation compared to other races, which results in more bees drifting from one colony to another, and a strong inclination to robbing, which can aid in the spread of disease. The Italians are considered good housekeepers and are comparatively resistant to European foulbrood (EFB)—the major reason why they replaced black bees. The lighter color of the Italian queen makes finding her in the hive easier compared to queens of the other two races. Italian bees produce brilliant white cappings, which are ideal for producing comb honey.

Caucasian bees are sometimes described as the gentlest of all honey bees. They are dark colored to black with grayish bands on the abdomen. They tend to construct burr comb and use large amounts of propolis to fasten combs and reduce the size of the entrance. Some of the newer strains, however, use less propolis. Because they propolize excessively, they are not considered suitable for producing comb honey. Caucasians are inclined to drifting and robbing but not excessive swarming. Colonies normally do not reach full strength before midsummer, and they conserve their honey stores somewhat better than the Italians do. They also forage at somewhat lower temperatures and under less favorable climatic conditions than do Italian bees and are reported to show some resistance to EFB. Caucasians are available but not common.

Carniolans are dark bees, similar to Caucasians in appearance, except they often have brown spots or bands on the abdomen. These bees overwinter as small clusters but increase rapidly in the spring after

the first pollen becomes available. As a result, their major disadvantage is excessive swarming. Due to their small overwintering cluster size, they are very economical in their food consumption, even under unfavorable climatic conditions, and overwinter well. They are not inclined to robbing, have a good sense of orientation, and are quiet on the combs. They are becoming more common. Some of the stock is identified as new world Carniolan and considered the better Carniolan strain by some beekeepers.

Hybrid bees have been produced by crossing several lines or races of honey bees. Initially, planned crosses frequently resulted in a line of very prolific bees that exhibit what is called hybrid vigor. With controlled matings, this vigor can be maintained. Commercial hybrids (Midnite and Starline) are produced by crossing inbred lines that have been developed and maintained for specific characteristics such as gentleness, productivity, or wintering.

Buckfast bees are a hybrid selected over a long period of time from many strains of bees from southwestern England. They have been shown to be more resistant to tracheal mites and better suited to the cool climate of that region. The stock has been imported into this country (eggs, semen, and adult queens via Canada) and they are easily available here in the United States.

The destructive presence of parasitic mites and drug-resistant diseases has led researchers and queen breeders to search for mite- and disease-resistant bees. Some of these stocks can now be purchased as queens. Interest in stock selected for more northern regions has also increased in popularity. One selection is the Buckeye strain from Ohio. Another is the West Virginia selection. The State of West Virginia, in an effort to improve the plight of beekeepers by reducing tracheal mite losses, has arranged for a queen breeder in an isolated area of Canada to supply a U.S. queen breeder with breeder queens obtained from Buckfast Abbey in England. These bees have demonstrated excellent resistance to tracheal mites and display all the traits of truly superior bees under West Virginia conditions.

Other groups of stock such as Russian, SMR, or Hybrid (sometimes Minnesota hybrid) are bees selected for greater mite resistance and/or improved hygienic behavior (hive cleaning—specifically, dead/dying brood removal), a trait that results in bees ridding their colony more quickly of potential harmful pathogens. As with any stock, querying

your potential supplier is best if you are uncertain about the claims made concerning the characteristics of the stock. Checking on the experience of other beekeepers that have used the stock is not a bad idea.

If you use hybrid bees or bees of a selected stock in your operation, be sure to requeen regularly. Allowing natural queen replacement usually leads to loss of hybrid vigor and sometimes causes colonies to be quite defensive and thus more difficult to manage.

---

## Apiary Location

Both beginners and established beekeepers should select each apiary site carefully. Throughout the foraging season, nectar and pollen sources must be within a short distance (roughly 1 mile) of the hives. Pollen is essential for brood rearing, and nectar (honey) is the bees' basic source of energy. While bees can be kept virtually anywhere, large concentrations of floral sources (and populous colonies) are needed to produce large honey crops.

Bees also need a source of fresh water so they can dilute honey, regulate hive temperature, liquefy crystallized honey, and raise brood. If a water supply is not available within  $\frac{1}{4}$  mile of the hives, you can provide a tank or pan of water with a floating board or crushed rock for the bees to land on. The water source does not need to be "pure."

Bees are less irritable and easier to handle when located in the open where they can get plenty of sunshine. Shade from trees retards the flight of workers and hinders finding the queen and seeing eggs within the cells. A southern or easterly exposure gives colonies maximum sunshine throughout the day. The apiary is best situated near natural wind protection such as hills, buildings, or evergreens (Figure 23). Other requirements are dry ground and good air drainage. Avoid windy, exposed hilltops or sites near the bank of a river that might potentially flood. You should also avoid apiary locations in heavily shaded woods or in a damp bottom land since excess moisture and less sunshine retard the flight of the bees and encourage development of such bee diseases as nosema and EFB.

Your accessibility to the apiary is important—perhaps the most important factor in apiary location because you must visit it throughout the year in all kinds of weather. Avoid locations where carrying



**Figure 23.** An ideal apiary location, shown in winter, with a natural windbreak and good air drainage. (Courtesy Maryann Frazier)

equipment and heavy supers of honey any distance will be necessary. Hives should be secluded from traffic, constant noise, and disturbance from animals and children. To discourage vandalism, placing colonies near a dwelling or area frequently visited yet screened from view if possible (a vegetative corral) is advisable.

Safety from pesticide applications that can affect colonies directly or the bees' forage is also important. Acquaint yourself with the pesticides commonly used in the area, and place colonies away from fields or other areas that are routinely treated with pesticides.

When selecting sites for outyards (apiary sites away from your residence), make inquiries to determine how many other beekeepers are operating in the area. A location can easily become overstocked with bees, which results in a poor honey crop for everyone. Beekeepers tend to neglect out-apiaries that are located too far from home. Increasing energy costs and efficient use of time should be included in each apiary site decision. Many farmers do not object to beekeepers locating outyards on some unused piece of farmland, but obviously you should obtain permission before considering any site owned by someone else. Outyards are usually "rented" with payment of harvested honey.

## Beekeeping in the Urban/Suburban Setting

Since legal problems with bees most often occur in cities and suburbs, beekeepers should manage bees so that they do not bother neighbors. You can take several precautions to decrease the chances of your colonies becoming a public nuisance.

Maintaining gentle colonies is imperative in highly populated areas. Keeping colonies with bees that try to sting each time they are examined, or that consistently hover around the bee veil even after the colony is closed, is not advisable in the urban setting. Selecting hybrid strains that have been bred for gentleness and requeening on a regular schedule will certainly help. If a colony becomes too defensive, requeening with a new queen will likely change colony temperament in a month or so.

Providing a source of water near the hives will stop a lot of unnecessary complaints. Otherwise, the bees may get their water from the neighbor's swimming pool, dripping water faucet, birdbath, children's wading pool, or hanging wash. Once they have become accustomed to a watering place, they will continue to use it throughout the season, and correcting problems after they develop is not always possible short of moving the bees.

Most colonies have a basic flight pattern as they leave and return to the hive. People and animals passing through this flight path could be stung. Bees also spot cars, clothing, and buildings in the vicinity of the hive by releasing their body waste in flight. Spotting from a single colony is generally not serious, but several colonies flying in one direction may make a car or house unsightly in a short time. If possible, do not allow hives to face children's play areas, neighbors' clotheslines, houses, and so forth. Planting a hedge (vegetative corral) or building a fence at least 6 feet high forces the bees to fly above head level and thus reduces the chance of encounters with pedestrians. Fences and hedges also keep colonies out of view, which helps reduce vandalism and concern by the neighbors who might have unfounded, but to them very real, fears related to bee stings.

When manipulating and examining hives, keep your neighbors foremost in mind. Weather and time of day influence the disposition of a colony. Colonies kept in the shade tend to be more defensive. Work the bees on warm, sunny days, when the field force

will be actively foraging. Avoid early morning and late evening manipulations if possible. Use smoke efficiently and work carefully and slowly to help prevent defensive behaviors by bees. During a nectar dearth, keep robbing at a minimum. Robbing stimulates defensive behavior. Keep examination time to a minimum and make sure honey supers and frames not being inspected are covered. All spare equipment stored outside should be bee-tight. Also, top entrances should be avoided in close neighborhoods during the summer season. Whenever a hive with a top entrance is opened and the supers moved, hundreds of bees will be flying around confused because their entrance is gone.

Swarming bees can be a major concern for neighbors. Even though swarming bees are quite gentle and seldom inclined to sting, the presence of a swarm in the neighborhood tends to excite people, and your apiary, rightly or wrongly, will likely be identified as the source of the swarm. Having sufficient equipment to manage your colonies and reduce swarming is a must (see "Swarm Management").

Part of being an urban beekeeper is good public relations. Beekeepers who permit their bees to become nuisances force communities to institute restrictive ordinances that are detrimental to the beekeeping industry. Do not keep more colonies in the backyard than the forage in the area can support or more than you have time to care for adequately.

Giving the neighbors an occasional jar of honey will also sweeten relations. Only a very small number of communities prohibit keeping bees. In most instances, violation of an ordinance or keeping bees in a negligent manner usually means moving the bees to another location.

#### **Rules of thumb for urban beekeeping:**

- Keep only gentle colonies and employ good swarm management techniques.
- Keep no more than four hives on a property of  $\frac{1}{4}$  acre or less.
- All hives within 20 feet of a property line should have a solid fence or vegetative barrier 5 feet or more in height between the hives and the property line.
- All hives within 30 feet of a public sidewalk or roadway should have a solid fence or dense vegetative barrier or be elevated so as to direct the flight path of the bees well above traffic and pedestrians.
- An adequate supply of water should be provided by the property owner or beekeeper from March 1 to October 31.



**An apiary site where bees have easy access to a source of water.  
(Courtesy Dewey Caron)**



## Handling Bees

### LIGHTING AND USING A SMOKER

The smoker is one of the most important pieces of beekeeping equipment. Used properly during colony manipulations, it will allow you to control the behavior of the bees. Moderate amounts of cool smoke repel bees and reduce defensive behavior.

Light a small quantity of fuel and puff the bellows until the material flames. Continue adding more fuel, while puffing the bellows, until the fire pot is full. When the smoke is hot or the smoker is throwing sparks, a handful of green grass or damp leaves inside the smoker lid will cool the smoke. As smoke volume becomes reduced, bluish in color, or too hot, refill the smoker and pack it down with your hive tool as you work. A properly lit and well-packed smoker provides enough smoke to work several colonies.

**CAUTION:** *Exercise extreme care when using your smoker. Sparks and flames will damage the bees' wings and body hairs. Carelessness can cause grass fires within the apiary, damage to your vehicle, and loss of honey house.*

Initially, you should blow several puffs of smoke into the hive entrance (Figure 24) and into any other hive openings such as cracks through which bees can escape. After waiting a few seconds, direct a few puffs of smoke underneath the hive top and inner covers as you remove them. While you remove frames for examination and as you separate the hive bodies, direct more puffs of smoke onto the top bars to repel



**Figure 24.** Before opening a colony of bees, blow smoke into the hive entrance and all other cracks and openings. (Courtesy Dewey Caron)

bees downward. One application of smoke usually lasts several minutes. As bees move back up to the tops of the frames, you normally can direct them back down with a couple puffs of smoke. Use the same procedure when reassembling and closing up the hive to help avoid unnecessarily crushing bees.

The amount of smoke needed will vary with genetic stocks, weather conditions, and intensity of the nectar flow. On warm, sunny days when a nectar flow is in progress, very little smoke may be needed. More smoke than usual will be needed during cool, cloudy weather. However, too much smoke may make bees run or boil out of the hive. Smoke is not usually needed when installing packages of bees or collecting swarms. Only small amounts of smoke should be used when removing honey supers and searching for the queens. Knowing the correct amount of smoke to use in a particular situation comes with experience.

### WORKING BEES

Beginners are naturally reluctant to spend much time examining their colonies and often are overly cautious about handling the bees for fear of damaging the colony. With proper clothing and equipment as described previously, handling bees is neither difficult nor dangerous.

After properly lighting the smoker and putting on your veil, approach the hive from the rear and work from either side. If several colonies or rows of colonies face the same direction, examine the front hive or row first so that you later work behind the disturbed colonies. When beginning to work a colony, blow two or three puffs of smoke across the entrance and under the lid to discourage the guard bees as described above. Use a puff or two every time a piece of equipment is removed or replaced. This keeps the bees under control and out of the way so few bees are killed as you work. Once the cover or a hive body is lifted up, remove it without letting it fall back down in place. Avoid bumping or jarring the hive during manipulation. In this way, you crush fewer bees and alarm the colony less. Work the bees when they are flying on clear, warm days between 10 A.M. and 4 P.M. During this period, most of the old bees are in the field gathering nectar or pollen. Bees are easiest to handle during a nectar flow. Work bees slowly and with care; unnecessary excitement leads to confusion and stings.

After removing the outer telescoping cover, place it underside-up on the ground close beside you near the hive. In this position it serves as a place to put the upper hive bodies when you are examining the lower brood chamber of the hive (Figure 25). Bees adhering to the inner cover when it is removed can be knocked off at the hive entrance or left if few in number. Set the inner cover out of the way or use it as a temporary cover for boxes that have been removed as you are examining the lower boxes.



**Figure 25.** As you work the colony, use the outer telescoping cover to support honey supers removed from top of colony. Note smoker held between knees. (Courtesy Dewey Caron)



**Figure 26.** Inspecting a frame over the top of the colony—note smoker handy at right foot. (Courtesy Dewey Caron)

Bees seal the inner cover to hive boxes and frames together with propolis at every point of contact. Use the straight end of the hive tool to pry them apart; start with the second frame in on the side you are working from. Free the propolis seal and pull the frame slowly out of the hive; look briefly for the queen while holding the frame over the top of the hive (Figure 26). If she is not on the frame, set it on end against the opposite side of the hive away from your feet near, but not blocking, the entrance. If the queen is on the frame, carefully set frame on end against the hive, take the next frame out, set it next to the first and then gently replace the first frame with the queen (you should know her location on the frame so you do not crush her as you replace the frame). After removing one frame, the rest of the frames can be more easily removed by breaking the propolis seal, moving them toward the open space, lifting to examine, and replacing them in order. Keeping combs in their original positions is desirable unless you feel a change in order will improve the condition of the colony.

To see eggs and young larvae, tilt the frame slightly so the sunlight comes over your shoulder falling into the cells of the comb. To look at the opposite side of the comb, raise or lower one end until the top bar is vertical, pivot the frame 180°, and bring the top bar back to a horizontal position. Repeat the process before replacing the comb in the hive. When you finish examining the combs of a hive body, replace the first frame that was removed into its original position. When reassembling the hive, smoke the bees so that they move down and pause slightly before replacing hive bodies or covers; most of the bees will move out of the way.

Some bee stings are inevitable, but with care most can be avoided. When stung, scrape the stinger away with your fingernail, hive tool, or other sharp object. Lightly smoke the area stung. If clothing—such as gloves—receives large numbers of stings, more bees will sting in response to alarm odors left by the stings. Learn to handle bees so that stinging is minimized. Launder gloves and suits that have been stung multiple times.

## Colony Management

### Early Spring Management of Overwintered Colonies

Early spring management is concerned primarily with sufficient food stores and secondly with disease and mite control.

In the fall, bees normally cluster between the combs near the bottom of the stored honey. During the winter, they gradually eat these stores while moving upward between the combs. As the cluster reaches the top of the hive, food reserves are depleted. Colony stores can be evaluated by tipping the hive from behind to assess weight or by checking the location of the cluster in relation to available foods. In February and early March, colonies should be assessed but not opened until the temperature is above 40°F (4°C), preferably when the sun is shining and during midday so that the bees have adequate time to recluster if necessary. When checking the location of the cluster, avoid disturbing it. Having adequate supplies of honey and pollen located above and to the sides of the cluster is of primary importance since once brood rearing begins early in January, the cluster may not leave the brood area to maintain contact with its food reserves.

Also, bees will not go down into lower boxes or move vertically in cold weather to get to food even if it is present. If the cluster is near the top of the hive, emergency feeding may be necessary. Check closely to see how much honey is available to the bees on either side of and above the cluster.

Colonies found to be short of stores before late March (early April in more northerly locations) are difficult to deal with. Feeding sugar syrup is not normally recommended because it adds stress on the clustered bees. The bees have problems inverting the sucrose and handling the excess water. Combs of honey in storage, taken from colonies with a surplus or from colonies that have died overwinter (deadouts), can be used to feed bees but only if you are certain they are free of disease. Remove several empty frames/combs in colonies that need winter feed and replace them with the frames of honey as close as possible to the cluster without disrupting it. Or, if available, you can place an entire super (partially or completely filled with honey) on top of the colony needing stores. Other early spring emergency feeding techniques include feeding sugar

candy or dry granulated sugar. Once the daytime temperatures increase enough to allow easy movement of the cluster and occasional flights, heavy sugar syrup can be fed to prevent starvation of colonies with inadequate stores. Feeding should be done inside the hive; several types of feeders are available. In order for bees to take full advantage of sugar syrup, sugar candy, or dry sugar, colonies must be strong, the temperature must be warm enough so that the bees can break cluster, and in the case of feeding sugar candy and dry sugar, adequate moisture must be available. For more details on feeding bees, see "Feeding Honey Bees."

#### CAUTION

- *Once you begin supplemental feeding, it should be continued until natural supplies of nectar become abundant, otherwise the bees may still starve.*
- *Feeding sugar syrup in the spring may help you save the bees from starvation, but it also acts as a stimulant for brood rearing and colonies may need increased management to keep them from swarming in mid-spring.*

Pollen must also be present for bees to raise brood. Check to see that sufficient supplies are stored in the brood area. You can increase or supplement pollen supplies with pollen substitutes available from bee supply dealers (see appendix). Such feeding is only cost effective if colonies are fed before natural pollen becomes reliable.

The equipment from colonies lost during the winter should be removed from the apiary, or at least sealed up as soon as possible to prevent robbing. Remove clusters of dead bees before they mold or decompose within the combs. Removing every dead bee from the cells is not necessary; after they dry up, you can shake them out or leave them for the bees to remove later in the spring. Any honey that remains will likely absorb moisture and ferment. Try to determine why the colonies failed to survive (e.g., disease, mites, too small a population, starvation). If you are certain that the honey is from a disease-free colony, use this honey on colonies needing winter feed or as feed for newly installed packages or nucs. You should destroy colonies that have died from American foulbrood. But you may save the hive bodies, supers, bottom board, and lid by scorching, ETO fumigation, or boiling in lye water (see "Managing Maladies").

During April, thoroughly inspect and clean up colonies. This will make management during the rest of the season easier. During inspection, however, be careful not to chill the brood. When the temperature is above 50°F (10°C) and there is little or no wind, you may hastily examine brood, but do not expose it for more than a minute or two. When the temperature is 65°F (18°C) and there is little or no wind, you can safely remove and thoroughly examine the frames. In addition to checking food stores, you should look for brood (an indicator of the presence and quality of the queen) and disease. Clean out the entrances and scrape the bottom boards. Remove excess propolis and burr comb from the frames. Replace old and damaged combs as you find them. Brood combs should be culled and replaced on a regular basis to inhibit the build-up of disease organisms. Cell size is also reduced over time due to the build-up of cocoons left in the cells by pupating bees, resulting in smaller adult bees. Some beekeepers cull combs on a regular basis according to a schedule they have established. If, when held up to the sun, no light passes through a comb, it should be replaced with foundation or newer drawn comb. Reverse the hive bodies if necessary; a queen located in the upper hive body may be slow to expand her brood nest if adjacent frames are filled with honey and she is reluctant to move downward. Do not reverse the hive bodies too early—this sometimes results in a split brood nest. A sudden drop in temperature may make it difficult for the bees to maintain brood nest temperature in this situation.

From mid-March through April, monitoring colony stores and brood expansion is important. As fresh pollen becomes available, it serves as a strong stimulus for brood rearing. As a result, the size of the brood area may increase faster than stores are replenished. Under these circumstances, colonies are vulnerable to starvation. If late March into April is warm and good flight weather occurs, feeding may not be necessary. However, if the weather inhibits flight activity, strong colonies with large brood areas can deplete food stores rapidly. Anytime a colony has less than 20 pounds of food (three full-depth frames of honey or the equivalent), it should be fed. Sugar syrup (one part sugar to one part water by volume or weight) will be the best source of feed at this time. Reversing hive bodies and feeding are stimulatory to bee colonies and might help weaker, slowly developing colonies to expand more rapidly.

Due to the introduction of varroa and tracheal mites into the United States, active mite control is necessary to ensure colony survival and productivity. Honey bee mites are now so widespread that you should assume your colonies are infested even if you have not seen mites. Typically, colonies are treated for mites in the late summer or early fall. However, treating for varroa in the spring may be advantageous. Also, if colonies were not treated for mites the previous fall, they might need to be treated in the spring. All drug and chemical control treatments must be completed well before the honey flow begins and supers are placed on colonies. In addition, if you decide to use IPM (Integrated Pest Management) techniques as a means of mite management, many of these techniques need to be implemented early in the season. See “Managing Maladies” for more details on chemical control and IPM of mites.

### **MAKING SPLITS OR INCREASES**

Dividing strong colonies in the spring is an excellent way to increase your colony numbers, make up for winter losses, and/or help prevent swarming. A strong colony can be split into two smaller colonies of about equal size. A queen cell or new queen should be introduced into the queenless portion at the time the split is made. An alternative technique is to make a division or nucleus colony by removing three to six frames of brood with adhering bees from one or more strong colonies (however, less fighting will occur if all adult bees are taken from the same colony) and placing these in a separate hive body or nucleus box. Place the frames with adhering bees in the center of the new hive. Next, introduce a new queen or queen cell and add sheets of foundation or drawn combs to fill up the hive body. You may place the new colony in the same apiary as the parent colony, but moving it to another location at least 2 miles away is better for preventing bees from returning to the parent colony. Replace the frames removed from the original colony with either drawn comb or new foundation frames; if using the latter, group the foundation frames together in the center of the top box.

Reducing the entrance of the new colony to only 1 inch will help prevent robbing. Feed the new colony sugar syrup or combs of honey. Add a second hive body after 4 to 6 weeks. If provided with plenty of bees and food, the new colony may become

strong enough to store some surplus honey by fall or at least be strong enough to overwinter. The parent colony from which the increase was made is less likely to swarm and should eventually produce as much honey as it would have without being split.

Strong colonies may also be divided within the same hive using a double screen. One advantage of splitting colonies using a double screen is that they can be made earlier in the spring since the heat of the “parent” colony below will rise and keep the brood in the split from becoming chilled. Place the old queen with about half the combs of brood, mostly open (unsealed) if possible, in the bottom brood chamber. Add an extra hive body with empty combs or combs with honey. Put the double screen on top of the second hive body with the entrance facing to the rear of the hive. Then put the second brood chamber containing five to six frames of brood, mostly sealed, and two combs of pollen and honey on each side, above the double screen. The upper portion of the split should contain about two-thirds of the bees since field bees are more likely to enter the lower portion, upon returning from a foraging trip. This may require you to shake extra bees into the upper portion from the combs of the bottom hive body. The upper unit should receive a new queen or queen cell at the time it is made up. When the sealed brood hatches, the new split will be composed of mostly young bees. This “split” can be removed from the parent colony a few weeks after the queen has started laying eggs.

#### **MANAGEMENT OF NEWLY ESTABLISHED COLONIES IN SPRING**

The primary management concern for newly established colonies (packages, splits, and nucs) in the spring is providing ample food stores and adequate space. The hive entrance should be constricted during initial buildup and enlarged when colony size increases and temperatures moderate. Colonies hived on frames of foundation must be fed continually with sugar syrup until the combs are completely drawn out and honey is stored in several of the frames (about a period of 4–6 weeks). Most colonies will need a second brood chamber added in 4 or 5 weeks. Colonies may be strong enough to be supered if started early and the season is favorable. By the fall, the same management procedures should be employed as for full-strength colonies.

### **Swarm Management**

Swarming is the natural instinctive behavior of honey bees to reproduce. But successful swarm management is essential for honey production. While this behavior is not fully understood, several recognizable factors contribute to swarming. Of primary importance is congestion in the brood area, which is related to population size and availability of space. The production and distribution of chemicals (queen substance) secreted by the queen also mediates swarming. When there is a shortage of these secretions, whether from lack of production by a failing queen or poor distribution due to congestion in the brood area, the bees are stimulated to make queen cells—the first visible sign of preparation for swarming (or possible supersedure). The weather may also modify swarming behavior. When colonies are strong and developing rapidly, a period of good weather following a period of bad weather seems to accentuate swarming preparations. Other factors that may contribute to swarming are poor ventilation, a failing queen, genetic makeup, and an imbalance in the age structure of the worker bee population.

In addition to raising several queens, colony preparations for swarming include decreased feeding of the queen, the rearing of more drones, and a reduction in foraging activity by the field force. As the workers feed the queen less royal jelly, her egg laying is reduced and her abdomen shrinks. In order to accompany the primary swarm when it leaves the hive, she must reduce her body weight by 50 percent or more. Normally, the primary swarm consists of the old queen, a few drones, and 50–60 percent of the workers. Just prior to emerging from the parent hive, the workers engorge themselves with honey. Swarms normally emerge from their hives on sunny, calm days, usually between 10:00 A.M. and 2:00 P.M., and initially settle nearby on a tree limb, shrub, post, or building (Figure 19, page 17). They may remain minutes to several days at this initial location before moving to a new cavity selected for them by scout bees. Occasionally, other smaller swarms may follow (afterswarms) with one or more newly emerged virgin queens.

Colonies that swarm rarely recover in time to produce a significant honey crop. Therefore, swarm control is essential to successful honey production.

Most swarming in the Mid-Atlantic region occurs during May and June. Swarm management to reduce the incidence of swarming should begin in April and continue through May. To minimize swarming, providing ample room in a colony for brood rearing and ripening/storing nectar is essential. Check the colonies every 8 to 10 days during the swarming season for queen cells in the brood area, which will be the first visible indication the colony is making preparations to swarm (or supersede their queen). Swarm cells are usually found on or near the bottom bars of the combs in the brood chamber (Figure 27), whereas supersedure queen cells are generally found on the face of the comb. You can quickly check for swarm cells by merely tipping back the top brood chamber and looking along the frame bottom bars of the top brood box (Figure 28). All swarm cells should be destroyed. Unfortunately, merely cutting out queen cells will not prevent swarming but may delay it, giving you time to employ other preventative measures such as splitting the colony. If you do not take such additional measures, within a few days the bees will usually start more cells to replace those that were destroyed. The earlier you detect queen cells and begin swarm management, the easier it will be to halt the process. Once there is a capped queen cell, the bees are committed to swarming.

Proper routine spring management can reduce the incidence of swarming. This involves ensuring adequate room for brood nest expansion and nectar storage as the weather warms and resources become abundant. In the early spring, the queen is normally located in the uppermost hive body. The presence of

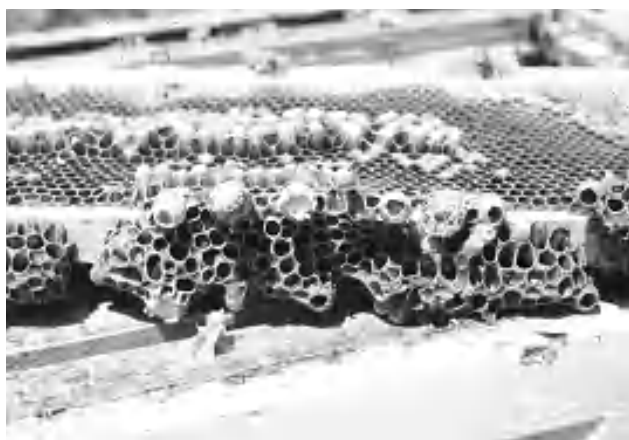

**Figure 27.** Swarm cells are commonly found on the bottom of combs in the top brood box. (Courtesy Dewey Caron)



**Figure 28.** To quickly check for swarm cells, merely tip back the top brood chamber and look between the frames. (Courtesy Dewey Caron)

stored honey may limit the size of the brood area. Reversing hive bodies can be a valuable aid in swarm prevention; move the brood nest (if in the top box) to the bottom and place the empty box from the bottom on top. The queen will want to move up as she lays eggs, and the now empty box on top will give her plenty of room for brood nest expansion and reduce congestion in the brood area.

Providing colonies with extra space before they need it is an important factor in swarm control (and honey production). Colonies usually need the first supers at the time of dandelion and fruit bloom. From then on, supply the colonies with at least one super ahead of their needs. A strong colony in late spring may need the equivalent of three deep-hive bodies just to provide sufficient room for the adult bees.

One of the best ways to prevent strong colonies from swarming is to split them or take divisions from them in late April or early May (see "Making Splits and Increases" under Early Spring Management). Colonies that have been split and parent colonies of those that have had frames removed to make up divisions will have sufficient space and will rarely swarm after such treatment. The new division will usually become a productive unit when established early in a year if a good nectar flow follows.

Once a colony is committed to swarming (queen cells are present), more drastic action is required to control swarming. The closer the queen cells are to emerging, the harder it will be to halt the behavior. One way to stop a colony with queen cells from swarming is by using a double screen to divide it temporarily (as described earlier under “Making Splits or Increases”), but without introducing a new queen. Normally, the bees will destroy the queen cells left in the lower hive body beneath the double screen, and those above the double screen will raise a new queen. After the swarming season has passed, the two units may be reunited. The new queen on the top above the double screen usually prevails as the colony’s queen, but you can ensure this by finding and eliminating the queen in the brood area below the double screen. This is an excellent way to requeen the parent colony. Alternatively, you may move the new divide in the top hive body with the new queen off the parent colony to make a new colony or to strengthen a weak one.

The Demaree method is another technique that can be employed to stop swarming once you have detected developing queen cells in a colony. Demareeing involves separating the queen from the brood and allows for the continuation of rapid colony growth. However, it requires a great deal of labor and time. First you must examine all frames of brood in the colony and destroy the queen cells. In addition, you must locate the queen and place her in the lower brood chamber with frames of capped brood. Then, collect frames of uncapped brood (eggs and larvae) and place them in a new upper brood chamber. Next, place a hive body of empty drawn comb above the box with the queen and open brood. Place a queen excluder on top of the second hive body and put the box of uncapped brood above the excluder, creating the new upper brood chamber. The colony is now at least three boxes in height with the first hive body containing the queen, empty combs, and frames of capped brood. The middle hive body contains empty drawn combs and perhaps a frame or two of capped brood; the top box (above the excluder) contains the young, uncapped brood frames.

The Demaree method creates the following conditions: the uncapped brood in the top super will attract most of the young nurse bees away from the brood nest in the bottom hive body, thus relieving crowding; the addition of empty drawn comb below

the excluder in a second hive body provides sufficient space for the queen to continue laying eggs. More space for egg laying will be available as the capped brood emerges. In 7 to 10 days, you should return to inspect the colony and destroy any new queen cells that may have developed in the lower or (more likely) upper hive bodies. A second round of moving capped brood into the upper hive body (transfer frames above that are now empty of brood to the box below) will produce an even stronger colony. Be sure the queen stays in the lowest chamber as you transfer frames. You can remove the queen excluder once the nectar flow begins; the frames you elevated above the queen excluder will become honey storage frames once the brood emerges.

### **EQUALIZING**

Equalizing colony strength makes all colonies productive, serves as a form of swarm prevention, and makes management easier during the rest of the year. Strengthen weak colonies by: (1) exchanging their positions with strong colonies in the same yard, (2) adding sealed brood from strong disease-free colonies, (3) adding queenless booster packages, (4) uniting two weak colonies, or (5) combining a queenless colony with a queenright colony. When exchanging bees and brood between colonies, be sure that the frames do not contain the queen and the colonies are free of disease. When adding adult bees to an existing colony or uniting two colonies, they should be separated by a sheet of newspaper to allow for a slow mingling of colony odors so fighting is kept to a minimum. In addition, when uniting colonies, the stronger colony and/or colony with the queen to be kept should be placed above the weaker colony. When capped brood (disease free) is moved from one colony to another, it can be done so without the aid of newspaper. Very little will be gained by adding unsealed brood to a weak colony as there may be too few young bees in weak colonies to care for the extra brood.

During spring inspection, you should determine the condition of the queen. Each colony must be headed by a young, vigorous queen that can lay a large number of eggs. A good queen lays a uniform brood pattern according to the strength of the colony, whereas a failing queen usually scatters her brood and sometimes lays drone eggs in worker cells. Colonies with queens over a year old are more likely to swarm than those with new queens.

Older queens either produce less queen substance as they age or enter periods in a cycle of lowered secretion that are more conducive to swarming. Therefore, requeening on a regular schedule (minimum of every 2 years) is an important part of swarm management. Even though summer or fall requeening is recommended, some requeening will need to be done in every season.

## Late Spring and Summer Management

Maintaining conditions favorable for brood rearing and honey storage, and mite and disease management are the primary management concerns during the summer. You should continue to check colonies to make sure they are not raising queen cells and sufficient storage space is available. Besides adequate space for honey storage, the bees also need space for handling incoming nectar. Nectar collected from flowers contains 50–80 percent water. Therefore, the nectar takes up much more comb space initially than it does after the excess water is evaporated and it is converted to honey. Fully ripened honey normally contains less than 18 percent moisture. Inadequate storage and handling space can result in honey-bound brood chambers, which limit brood rearing and surplus honey storage. During the spring nectar flow, the trend should be to oversuper. Research has shown that empty combs stimulate foraging behavior and honey production. In contrast, near the end of the last nectar flow (in summer or fall, depending on location) undersupering is better because it forces the colony to consolidate its stores—an important step in preparation for winter.

### Rule of thumb:

Oversuper in spring; undersuper in fall.

Add supers to the colonies according to colony strength and the amount of incoming nectar. Adding too much space to a weak colony can result in wax moth problems. A colony is ready to receive additional supers when the previous one is  $\frac{1}{2}$  to  $\frac{2}{3}$  full and the bees have started sealing the honey. Another indicator is the presence of white, freshly secreted wax (termed whitening) along the lower edge of the top bar (Figure 29). Some beekeepers super on specific dates knowing from experience when the main nectar plants start to bloom, but they also must keep an eye on plant conditions as seasons vary depending on environmental conditions.

There are two ways of adding supers: top supering and bottom supering. With top supering, each new super is placed on top of the last one. With bottom supering, new supers are inserted between the brood nest and the partially filled supers. Top supering is the more popular method because it requires less work. However, some beekeepers prefer bottom supering because they feel that the partially filled supers at the top draw the bees up into the empty one. Bottom supering also produces less travel stain to newly capped honey cells since fewer bees have to walk over the combs in the upper supers. Unfortunately, bottom supering may allow the queen to move into the supers if there is no queen excluder, and it makes further evaluation of the nectar flow more difficult. In addition, bees may discontinue work in the upper supers during a light flow, thus resulting in only partially filled supers at the end of the season.

Top supering means you need only look into the top of the hive when deciding if more supers are needed. Sometimes bees do not move into a super added on top. A useful alternative supering technique is to bait supers when adding them at the top by moving one or two frames from the topmost super into the newest super to be added. Alternatively, dripping sugar water onto the combs as you top super helps ensure that the bees expand into the new super. You may still end up with supers only partially filled if the nectar flow is weak.



**Figure 29.** Freshly secreted wax along the lower edge of the comb's top bar indicates that another super is needed. (Courtesy Dewey Caron)



Bees more readily accept honey supers with drawn combs than those containing frames of foundation. Colonies provided with drawn combs immediately have space to store nectar and honey, whereas colonies that receive foundation must first build (draw) combs before they can store nectar and honey. The delay can reduce the amount of honey produced and increase the likelihood of swarming. Such colonies also are more likely to store nectar in the brood nest, thus restricting the queen's laying space. A good nectar flow must be underway before adding foundation; thus, you should super more conservatively when using foundation. Bees can be induced to work foundation either by bottom supering or by exchanging some drawn combs from below with frames of foundation.

Parasitic mites and diseases can be a problem for bees and beekeepers throughout the year, and actions such as monitoring and implementing management tactics such as chemical control and/or IPM techniques may be necessary throughout the active season. For more details on managing these problems, please see "Managing Maladies." Other colony problems that require attention during the summer are generally associated with queen failure, disease, pesticide kills, or pests such as skunks, bears, wax moths, and so on. How quickly a colony recovers from such conditions often depends on how soon the beekeeper discovers and addresses the problem.

## Fall Management

Fall management is primarily concerned with preparing honey bee colonies for winter. Successful wintering depends largely on the condition of the colonies in the fall. Prior to parasitic mites, beekeepers experienced about 10 percent colony loss each winter due to poor management, starvation, weak colonies, or other unexplained reasons. Since tracheal and varroa mites became widespread, winter losses have increased—some years exceeding 50 percent. However, winter losses can be reduced if colonies are well managed.

Many beekeepers think of fall as the beginning of the beekeepers' new year because the success of the colonies in the coming year will depend largely on how well they were managed in fall. Typical fall management consists of checking colonies for the proper arrangement of hive equipment, proper hive ventilation, adequate food stores, and adequate

colony strength once or twice during the fall. Successful wintering largely depends on these factors coupled with the management of mites and diseases. If you plan on using chemical miticide treatments for varroa and tracheal mites, you should apply them in the late summer or very early fall if warranted and then remove them from colonies prior to winter. A fall Fumidil-B® treatment for nosema disease is also recommended. For more detailed information on mite and disease control please see "Managing Maladies."

Remove all surplus honey and any honey supers that are empty or only partly filled from colonies during the summer, at the end of the fall honey flow or after a killing frost. All queen excluders must be removed before winter to prevent the queen from becoming trapped below the excluder when the cluster moves upward during winter. If you did not use queen excluders, consolidate the brood in the lower hive body as much as possible. Never winter colonies on foundation or on partially drawn frames; these do not allow proper cluster formation and will cause bees to freeze. Remove any extra equipment.

Most Mid-Atlantic colonies are wintered in their summer locations with reduced entrances and no wrapping or other insulation (Figure 30). In more northerly locations, winter survival can be increased somewhat by wrapping hives with tar paper and/or insulating the tops of hives with straw or other



**Figure 30.** Colony ready for winter with an upper entrance and bottom entrance fitted with hardware cloth to keep mice out. (Courtesy Dewey Caron)

insulating material. However, for large numbers of colonies, the costs of time and materials involved can be high. Commercial and some part-time beekeepers move their colonies south (to Florida or the Carolinas) where they can improve winter survival and make a honey crop.

Mice are a cold-weather pest of bee hives. During fall and winter when bees are clustered, field mice and deer mice commonly enter hives to take advantage of the warm, dry hive for nesting purposes. They usually do not disturb the bee cluster. However, mice will chew large holes in four to five adjacent combs to make a space for their nests. Hardware cloth (three-mesh to the inch) or an entrance cleat (or entrance reducer with a vertical opening of less than  $\frac{1}{2}$  inch) placed in the main hive entrance in early fall will help to keep mice out of hives (Figure 30, lower insert).

Some beekeepers also use entrance cleats to restrict the entrance to about  $\frac{3}{8}$  inch high by 4 inches across to reduce wind entry and help conserve the heat generated in the colony. If you use a cleat, place it with the opening turned up rather than down to reduce the chances of the entrance becoming clogged with dead bees and debris.

Providing colonies with both upper and lower entrances can increase winter survival. A top entrance is particularly important for providing additional ventilation, which facilitates removal of excess moisture from the hive. Top entrances help to keep the hive dry, the bees healthier, and the combs free from mold, while protecting the bees from suffocating if the lower entrance becomes clogged with dead bees or snow. The top entrance may be a  $\frac{5}{8}$ -inch hole bored through the top hive body at one side of the hand hold or a small stick, stone, shim, or rounded carpet tack inserted under the front edge of the inner cover (Figure 30, upper insert). The outer cover fits over this entrance, but you must push it forward to create a gap between the two covers that will allow the bees to come and go freely once the weather is warm enough for them to fly. Place both top and bottom entrances in the front of the hive so as not to create a steady draft. In addition, elevate the rear of the hive slightly higher than the front to prevent rain and condensation from pooling on the bottom board.

Colonies need sufficient room for cluster formation and winter honey stores. Normally, two to three

hive bodies (or the equivalent in supers) are required with colonies having at least 60 pounds of honey for winter food by late fall. The brood nest area should also contain several frames of stored pollen, which is essential for early spring brood rearing and buildup. Two deep hive bodies (or the equivalent in supers), bees, and sufficient stores for winter should weigh about 125 pounds

The quality of winter food is of considerable importance. Thin or unripe honey gathered from wild asters in late fall may cause dysentery if the bees are unable to properly ripen the nectar due to cold weather. Aster honey, a common Mid-Atlantic fall nectar source, crystallizes very rapidly, which can prevent the bees from moving it into the clustering space or can cause them to starve if they are confined without water-gathering days in the early spring (bees use water to reliquefy crystallized honey). Feeding syrup in the fall can help to improve or correct this situation.

Distributing food stores in the hive is very important for successful wintering. Most of the honey should be located above the cluster because the bees will move upward during the winter as they consume their stores. Even if a colony is starving, the bees will not move down to reach honey that is located below the cluster. The uppermost hive body or super should contain a minimum of 40–45 pounds of honey. A small portion of empty comb is helpful for proper cluster formation and heat conservation; bees cannot cluster on capped honey. If the uppermost hive body is totally honey-bound, then one or two frames in the center should be exchanged with partially filled ones from the lower hive body; the filled frame can be put on either side of the lower box or used to feed weaker colonies.

If stores are not sufficient, feed the bees concentrated (heavy) sugar syrup during September and October until they have at least the equivalent of nine full-depth frames of honey (in addition to pollen stores). Prepare this syrup by mixing white granulated sugar with hot water at a ratio of 2:1 (two parts sugar to one part water) by volume or weight. If necessary, heat but do not boil the water to dissolve all the sugar. Allow the syrup to cool before giving it to the bees. Each gallon of syrup fed to bees increases their reserves by about 7 pounds.

Fall is an ideal time to apply treatment for nosema disease, a protozoal infection of the bee's gut. Nosema can cause dysentery (bee diarrhea), decreased honey production, and increased queen supersedure. Nosema can, but rarely does, kill colonies, most often during late winter or early spring. Fall nosema treatment consists of mixing the appropriate amount (follow package directions) of Fumidil-B® powdered medication into heavy sugar syrup and feeding each colony 2 gallons of medicated syrup during mid-fall. Some beekeepers also apply an early spring nosema treatment, using light (1:1) sugar syrup. However, spring feeding of overwintered colonies is probably not cost effective.

Only strong colonies should be overwintered. Weak colonies (five or fewer frames of bees and brood) should be united with strong colonies or combined with other weak colonies during late summer or early fall to allow the bees time to rearrange their brood nest and stores before winter (see uniting colonies under "Equalizing," page 29). Weak colonies that manage to survive the winter will build up slowly in the spring and will probably remain weak throughout the spring flow.

A large population of young bees that will live 5–6 months is vital to successful wintering. Strong colonies with young queens are a must; young queens lay more brood in general, lay later into the fall, and begin laying earlier in the spring than older queens. Extra brood in the fall and early spring is important in helping colonies survive tracheal mite infestations. We recommend you periodically requeen colonies, preferably every other year. Fall requeening should be done during the goldenrod and aster flow in August or early September so that the colony has time to build up and organize its nest before winter.

## REQUEENING

Young vigorous queens are essential to successful beekeeping. Most queens have a maximum reproductive period of approximately 2 years, so replacing the queen at regular intervals or when there is any sign of failure is important. Some beekeepers requeen annually rather than risk a queen failing during the build up or production period of the second summer.

While requeening in the spring is easier because the colonies are smaller and the queen easier to find, there are several advantages to "fall" (late summer

to early fall) requeening. Northern-bred queens preferred by many beekeepers are available only in the summer and fall. In addition, better climatic conditions and larger drone populations favor queen rearing and mating during the summer in comparison to early spring. Young vigorous queens will lay eggs later into the fall, so a colony has a higher percentage of young bees to survive the winter. Fall requeening stimulates rapid spring buildup and aids in swarm control. Finally, young queens start laying earlier in the spring and are less likely to be superseded the following year.

Requeening is most successful during a nectar flow. Young worker bees usually do not pose a threat. In the absence of a nectar flow, feed the colony sugar syrup during requeening. Do not start dequeening the colonies until the new replacement queens are available. Requeening will be more successful if only a short time elapses between the time the old queen is killed and the new one introduced. Introduce queens during the warmest part of the day, except when there is danger of robbing. Also check for any queen cells and remove them before attempting to introduce a new queen.

Many beekeepers in northern areas like to requeen in early September, during the goldenrod flow. This floral source has a distinctive aroma associated with this nectar, which helps to mask the odor of the new queen as she is being introduced.

Several techniques are commonly used for introducing a queen. Unfortunately, there is no single sure way of replacing an old queen with a new one. The first step in requeening can be the hardest—finding and killing the old queen (dequeening) (Figure 31, next page). You can usually find the queen by searching through the colony frame by frame. Concentrate on areas where eggs are located. Use a minimal amount of smoke to keep the queen and bees from running on the combs. You can also use a queen excluder as an aid in locating the queen. Place a queen excluder between the brood boxes and then return to the colony after 4 days. The queen will be in the box where eggs are found. Remove the hive body with the eggs and place it on the outer cover or another bottom board. Carefully inspect each frame for the queen until you find her. If the queen continues to be elusive, try the following technique: let the colony become quiet, then remove the hive body with the eggs (and queen) and place it on the outer cover or another

bottom board, if this has not already been done. Place the hive body without eggs on the bottom board and place a queen excluder on top of this hive body. Then place an empty hive body, above the queen excluder. Remove the frames one at a time from the hive body with the eggs and check them again for the queen. If you do not see her, shake the bees into the empty hive body. Check the frame again and, if the queen is not among the few bees left on the frame, put it aside. Repeat this procedure until all combs have been checked and all adult bees have been shaken into the empty top hive body. If bees attempt to crawl out of the upper body, smoke them lightly to make them return to the inside. If large masses of bees collect on the inside of the empty hive body, brush them onto the excluder. As worker bees pass through the excluder to rejoin the brood frames, the queen will be confined in the top box by the excluder. She can usually be found on the excluder trying to find a way to the bees and brood below.

A standard method of introducing a new queen into a dequeened colony is to insert a mailing cage with the new queen between the top bars of two frames and let the bees release the queen from the cage. For the best results, remove attendant bees from the queen cage before introduction. Just before placing the cage in the hive, take a sharp object such as a small nail and poke a tiny hole through the candy plug that will be present at one end of the



**Figure 31.** Looking for a queen can sometimes be a challenge. If you do not find her, place a queen excluder between the boxes and return after 4 days; she will be in the box with eggs. (Courtesy Dewey Caron)

mailing cage (Figure 15, page 14). Be careful not to injure the queen. Position the queen cage between two frames containing young brood so that the screened side is available to the worker bees and not flush against the comb (Figure 16, page 15). If the screened side faces downward (horizontal position), more bees will have contact with the screen and more ready access to the queen and her chemicals, which increases the chances of her acceptance. If the cage is placed in a vertical position, the candy end should be up. Do not disturb the hive for at least a week after introducing the cage. If the queen has not been released when you return to the hive, you may set her free with little danger.

You may use a push-in cage to introduce the queen with greater safety. This cage permits the queen to come in contact with the comb for a short time and take on the odor of the hive before she is released. A push-in cage is shaped like an open-sided box made from ordinary window screen or eight-mesh hardware cloth. It can be any size, but most are made from a 4-inch square piece of screen folded along each edge with the corners clipped to form four sides approximately  $\frac{1}{2}$  inch wide. Directly release the queen onto a brood comb, preferably with emerging brood and/or nectar cells, and gently place the cage over her. Push it deep enough into the face of the comb so that the bees cannot readily gnaw through the comb to reach the new queen (Figure 32). A few days later, remove the cage. In the interval, the queen will have been accepted by the emerging bees inside the cage and her chemicals passed to workers outside the cage so she is then readily accepted by the bees of the colony.

Small colonies of young bees most readily accept queens, especially during a nectar flow. Make up a nucleus colony filled with combs of emerging bees and food. Feed the colony a light syrup a few days before and after you introduce a new queen directly to them. When the queen is laying well, unite the



**Figure 32.** Introducing a queen using a push-in cage. (Courtesy Maryann Frazier)

nucleus colony with the larger colony by using a double screen or newspaper to allow for the slow mingling of colony odors. Before introducing the nucleus colony, be sure the established colony is queenless and without queen cells.

### ROBBING

During periods of nectar dearth, particularly in the fall after a killing frost, avoid actions that encourage robbing behavior. This is especially important when removing the fall honey crop or preparing colonies for winter. Exposed honey in frames or supers left outside the hive stimulates scout bees in the same way that rich nectar sources do. Colonies have little respect for each other when it comes to the possession of honey. Robbers are quickly recruited and quite suddenly can throw the whole apiary into an uproar. Nucleus, weak, and queenless colonies may be quickly robbed of all their honey stores because they are not strong enough to keep the colony protected. Strong colonies may lose many workers in robbing or in fighting robbers to protect their own store, and once robbing begins in earnest, it may be some time before colonies return to routine activities. Robbers are easily recognized because they eventually become smooth, shiny, and almost black.

Robbing is a behavior that is difficult to control once it gets started. Careful beekeepers know that the best way to combat robbing is through prevention. While working in the apiary during times of dearth, proceed with caution; open the hive carefully, work quickly, and never leave combs of honey or supers exposed. Place all combs taken from the hive in an empty hive body protected with a bottom and a cover. Spare outer-telescoping lids work well. Working the bees toward evening will reduce robbing problems. If colonies must be fed, provide feed during inclement weather or in late evening or early morning. Feed should always be placed inside the hive. If you notice robbing in the apiary, immediately close open colonies and reduce the entrances of all hives according to colony strength. You also should seal all cracks or openings in the equipment through which robbers might gain entrance.

In addition to reducing the entrance, it may help if you lay a board from one side of the bottom board to the other. This forms a tunnel through which the robbers must pass and in which guard bees can congregate and defend the hive. A large bunch of weeds or grass loosely stuffed in the entrance will also hinder the robbers.

### FEEDING HONEY BEES

The natural honey bee diet consists of pollen, nectar or honey, and water. Honey is the bees' source of carbohydrates or energy supply. Proteins, vitamins, minerals, and fats are obtained from pollen. Any time the natural food stores of a colony are low, the beekeeper must begin emergency feeding. An established colony should have at least 15–20 pounds of honey or the equivalent of three to four full-depth combs of honey in reserve at all times. The need to feed bees occurs mostly in late winter/early spring and sometimes in the fall.

Colonies found short of food stores before late March are difficult to manage. Feeding heavy sugar syrup at this time is not normally recommended because it places an additional stress on the clustered bees. Inversion of the sucrose and handling excess water causes problems for honey bees. Too much moisture in the bees' diet causes dysentery. Three food sources considered suitable for emergency feeding at this time of year are combs of honey (from disease-free colonies), dry sugar, or sugar candy.

Some beekeepers save frames of honey from disease-free colonies in the fall for spring feeding. If these are available, place two or three combs of honey as near the cluster as possible without disrupting or breaking it. If you do not have frames of honey in storage, you may alternatively take frames from colonies that have died during the winter or from colonies with a surplus. Occasionally, such feeding practices are necessary to save a colony from starvation. In these circumstances, break the cappings on the comb to give the bees quicker access to the honey. Never feed frames of honey unless you are absolutely sure they are free of disease, particularly American foulbrood.

**CAUTION:** *Never purchase honey from other sources to feed bees and never feed honey from colonies that you suspect are diseased.*

As an emergency feed, you may pour dry, granulated sugar around the hole of the inner cover (Figure 33, next page) or spread it on a piece of paper that has been placed on frame top bars. You can also use specially constructed sugar holders (rim feeders) that replace the inner cover beneath the top cover. To take full advantage of the dry sugar, colonies must be strong, temperatures must be warm enough so the cluster can be broken, and

adequate moisture must be available. In some instances, bees will carry dry sugar out of the hive and discard it. This approach is not well suited to colonies that need food immediately to survive.

Probably the best approach to emergency feeding in early spring is to use sugar candy (Figure 34) made from the following recipe:

### SUGAR CANDY

15 pounds sugar

3 pounds glucose or white corn syrup

4 cups water

$\frac{1}{2}$  teaspoon cream of tartar

Dissolve the sugar in the water by stirring and boiling the mixture until the temperature of the syrup rises to 242°F (115°C). Use a candy thermometer to monitor the temperature while heating the syrup. Let the syrup cool to 180°F (81°C), then beat until thick. Pour the candy into molds lined with wax paper. Place a cake of sugar on two small,  $\frac{1}{2}$  inch square strips of wood in an empty super above the cluster of bees. Cover the candy and the space around it with cloth or newspaper to keep it warm. Remove any remaining candy and feed syrup when the weather gets warm in March or April.

Sugar syrup is the most common feed for bees when the weather permits easy movement of the cluster, occasional flights, or when the outside temperature is above 40°F (4°C). Make this syrup by dissolving either cane or beet sugar (sucrose) in water. Do not use brown sugar, molasses, and other similar materials containing sugar as feed. You can also safely feed bees high-fructose corn syrup (HFCS or isomerized syrups) and extracted disease-free honey from your apiary, diluted  $\frac{1}{4}$  to  $\frac{1}{2}$  with warm water. Before April 1, feed a heavy sugar syrup made up of two parts sugar to one part hot water by volume or weight. To make sure all the sugar dissolves, you may have to heat the water. Be careful not to burn the sugar; caramelization can be harmful to bees. Such a mixture will not freeze at temperatures as low as -10°F (-12°C). During the foraging season, the syrup is mixed lighter—one part sugar to one part water by volume or weight.



**Figure 33.** In an emergency, colonies can be fed dry, granulated sugar. Note protective winter wrap that folds over the top when outer cover is replaced. (Courtesy Dewey Caron)

You can use several methods and types of feeders to feed sugar syrup to honey bee colonies. Under almost all conditions, feeding should be done inside the hive. Syrup feeding excites and stimulates colonies. When weather allows foraging, but there is little forage available, this feeding stimulus may lead to robbing in the apiary, particularly of those colonies receiving the food and where there is spilled syrup (for example, leaking from feeders).

Boardman (entrance) feeders do not work well in cool weather. The syrup gets too cold, and the bees do not come down to get it unless the weather is warm. Colonies that need to be fed usually require larger volumes of syrup that entrance feeders cannot supply and such feeders are prone to robbing. Therefore, we recommend that syrup feeding only be done within the hive.



**Figure 34.** A colony being fed sugar candy in the winter over the hole in the inner cover.



**Figure 35.** Colony being fed sugar syrup over the hole in the inner cover. (Courtesy Dewey Caron)

An inverted pail or jar placed on the top bars of frames of the upper hive body or over the hole in the inner cover is an excellent method of feeding syrup in the spring (Figure 35). This is the warmest part of the hive where the bees are usually clustered. Make sure the holes in the feeder are not too large; you are interested only in keeping the bees alive, not in their storing large quantities of sugar syrup. Usually six to twelve holes made with the tip of a 4d nail in the lid of feeding jar/can are sufficient. To test each feeder before placing it on the hive, invert the full feeder over the top bars. A small amount of syrup will run out until a vacuum forms in the container. Do not use the feeder if the syrup leaks out after the vacuum has had time to form. Protect the feeder with an empty super, and replace the hive cover and place a brick or stone on top to signify you are feeding that colony and to keep the empty hive body and cover from being blown off by the wind.

A division board is another widely used type of internal hive feeder. This feeder, either wood or plastic, replaces a frame inside the hive. To prevent leakage, coat the wooden feeder with wax and fill it with water to cause swelling. Add a wooden float or U-shaped piece of hardware cloth to help the bees get to the syrup without drowning. The division board feeder holds about 2 quarts of syrup and can be refilled without removing it from the hive. Placing it in one of the outermost frame positions makes it possible to fill the feeder by tilting or sliding the above boxes to one side rather than removing them. Some beekeepers who feed routinely leave these feeders in the hive year-round.

An alternate method of feeding sugar syrup is to pour the syrup into the empty cells of a drawn comb. Fill one side and then turn the comb over carefully to fill the other side. Since a solid stream of syrup poured onto a comb does not penetrate the cells, use either a sprinkling can or feeder can with many holes. You can fill the combs before taking them to the apiary with little loss of syrup. After filling, give each comb a good shake over a receptacle to remove surplus syrup. Place two or three syrup-filled frames adjacent to the brood nest in the hive.

Feeders made of wood or plastic that cover the entire top of the hive also work well and allow large quantities of syrup to be fed rapidly. Such feeders work best for hives on level ground.

**CAUTION:** *Feeding sugar syrup early in the spring is a strong stimulus for brood rearing. Colonies quickly become dependent on this food source, thus feeding must be continued until weather conditions and floral sources allow the bees to survive without supplemental feeding.*

Pollen is essential for the production of larval food and for brood rearing in honey bee colonies. Inadequate pollen stores in the immediate area of the winter cluster hinder brood rearing and, therefore, the development of strong colonies. If colonies are found deficient in pollen stores early in the spring, you can extend their pollen supplies by feeding either pollen supplements or substitutes early in February–March. A pollen substitute is a protein source containing all the essential nutrients for bees but without pollen, whereas a pollen supplement is a protein source that has some pollen added to it. The natural pollen greatly enhances the bees' willingness to make use of the protein source.

Several commercial pollen substitutes are available for feeding honey bees. These include large portions of carbohydrates (sugars) in addition to the protein component. Supplies of natural pollen are also commercially available. However, feeding pollen from an unknown origin could be a source of disease infection. The best way to obtain pollen for supplemental feeding is to trap your own pollen during the summer. It can be either dried and stored in a tight container or frozen fresh.

Dry commercial supplements or substitutes are best fed in early spring; they should be placed on the inner cover, just as dry sugar is fed. A more efficient way of feeding supplements/substitutes is to make up cakes of doughlike consistency.

**Pollen Supplement****One cake**

- 2 ounces pollen
- 6 ounces soybean flour
- 5½ ounces water
- 10½ ounces sugar

**Thirty-two cakes**

- 4 pounds pollen
- 12 pounds soybean flour
- 11 pounds water
- 21 pounds sugar

Prepare by mixing pollen and sugar together with hot water, and then add soybean flour until the mixture has a peanut butter consistency. Recipes contain about one part pollen to three parts soybean flour mixed with heavy syrup (two parts sugar to one part water by volume).

Brewer's yeast (one part to six parts soybean flour by weight), powdered skim milk (one part to four parts soybean flour), or additional soybean flour may be used as substitutes when pollen is not available. The doughlike mixture is normally pressed between two sheets of wax paper to form a patty that is ½ to ¾ inch thick and weighs from ½ to 1 pound.

In the bee yard, remove the wax paper from one side of the cake and place the cake directly over the cluster on the top bars, with the wax paper side up. Turn the inner cover upside down to make room for the cake. Add another cake every 7 to 10 days or before the previous one is entirely consumed. Once started, the pollen substitute, either the cake or dry material, should be available to the bees as long as natural pollen is lacking. Any interruption in the feeding of the pollen substitute may cause a setback in brood rearing. Providing protein (pollen) in colonies early in the spring will be most effective in years when adverse weather conditions delay the flowering of plants and prevent bees from collecting adequate supplies of natural pollen. It also will be an effective management technique if strong colonies are needed early in the spring; for example, when splits or divisions are used to replace large winter losses, in preparation of colonies for pollination rentals, and in areas with early nectar flows.



**A beekeeper examines a frame of brood and bees from a strong nucleus colony in spring. Note the hive tool held in the hand as the frame is viewed. (Courtesy Maryann Frazier)**



---

## Summary of Management Practices throughout the Year

### JANUARY

- Begin emergency feeding with frames of honey, sugar candy, or dry sugar, if necessary.
- Clean, paint, and repair equipment.
- Check apiary for vandalism, hive covers blown off, and so forth.
- Order packages, nucs, queens, if not done in December.
- Consider your mite and disease management program and order/construct the necessary materials (monitoring boards, screen bottom boards, drone foundation, chemicals, and so on).

### FEBRUARY

- Check colonies for honey stores.
- Continue emergency feeding with frames of honey, sugar candy, or dry sugar, if necessary.
- Continue to prepare equipment for coming season.
- Clean up dead colonies.

### MARCH

- Continue emergency feeding, if necessary.
- Feed pollen supplements or substitutes, if needed.
- First quick inspection of brood nest, if weather permits.
- Check for and clean up dead colonies.
- Clean out entrances and bottom boards.
- Assemble section honey supers.

### APRIL

- Monitor colony stores, especially if weather is cold and wet.
- Inspect brood nest for laying queen, disease, and so forth.
- Introduce package bees on drawn combs.
- Requeen colonies with failing queens.
- Reverse brood chambers when weather moderates.
- Add supers to strong colonies at the time of maple or dandelion bloom.
- Unite weak colonies.
- Equalize strength of all colonies.

### MAY

- Monitor colonies for queen cells.
- Control swarming.
- Add more supers as necessary (oversuper).
- Place queen excluder below shallow super on colonies for comb honey.
- Install packages on foundation.
- Split strong colonies.
- Capture swarms.
- Cull and replace defective combs with full sheets of foundation.
- Begin implementing an IPM program for the control of mites.

### JUNE

- Continue to check for queen cells.
- Rear queens if you prefer your own stock.
- Check colonies for disease and monitor for mites.
- Remove comb honey supers when properly sealed.
- Provide plenty of super space.
- Control swarming.
- Capture swarms.

### JULY

- Remove comb honey supers when properly sealed.
- Check for queen cells, especially in colonies used for queen rearing.
- Add sufficient super space (undersuper).
- Remove and extract early season honey crop.
- Freeze comb honey to prevent wax moth damage.

### AUGUST

- Check colonies for disease and monitor/treat for mites.
- Remove and extract summer honey crop.
- Remove section supers.
- Do not work bees unless necessary to avoid robbing.
- Add more supers if needed.



## Managing Maladies

### Diseases, Parasites, and Pests and Their Control

The first line of defense in protecting your colonies from diseases, mites, and other maladies lies in your ability to detect and recognize early symptoms of these problems. Failure to recognize problems early can lead to decreased productivity and weak and even dead colonies.

### Brood Diseases

#### AMERICAN FOULBROOD

American foulbrood (AFB) is an infectious brood disease caused by the spore-forming bacterium *Paenibacillus larvae*. It is the most widespread and destructive of the brood diseases. Adult bees are not affected by AFB. *Paenibacillus larvae* occurs in two forms: vegetative (rod-shaped bacterial cells) and spores. Only the spore stage is infectious to honey bees. Larvae less than 53 hours old become infected by swallowing spores present in their food. Older larvae are not susceptible. The spores germinate into the vegetative stage soon after they enter the larval gut and continue to multiply until larval death. New spores form after the larva dies. Death typically occurs after the cell is capped, during the last 2 days of the larval stage or first 2 days of the pupal stage.

Brood combs in an infected colony have a scattered and irregular pattern of capped and uncapped cells. Infected cells are discolored, sunken, and have punctured cappings (Figure 36). This “pepperbox” appearance contrasts with the yellowish-brown, convex, and continuity of sealed cells of a healthy brood comb (Figure 8, page 6). Dead larvae

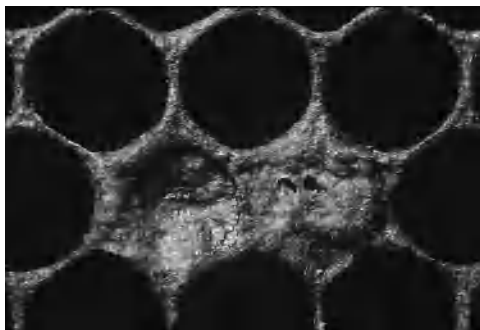

**Figure 36.** Brood cells from a colony with American foulbrood, showing sunken, punctured cappings. (Courtesy Scott Camazine)

change gradually from a healthy pearly white to light brown and then to a dark coffee-brown. With American foulbrood, this color change is uniform over the entire body. Within a month or so, these dead larvae dry down into brittle scales that are almost black. Each scale contains as many as 100 million spores. The scales lie flat along the lower walls of the cells with the rear portion curving partway up the bottom of the cell. House bees cannot completely remove the scales from the cells. During the early stages of decay—up until about 3 weeks after death—the dead larvae have a glue-like consistency. The cell mass may string out for an inch or more when a toothpick is inserted and withdrawn; this is known as the “ropy stage” (Figure 37). When death does not occur until the pupal stage, pupae undergo the same changes in color and consistency as larvae. In addition, a pupal tongue sticks up from the remains toward the top wall of the cell; this is one of the most characteristic symptoms of American foulbrood but may not always be present. (Figure 38).

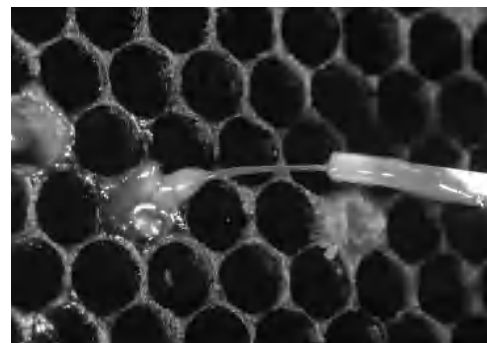

**Figure 37.** American foulbrood; larval remains “roped out” when a match stick is inserted and withdrawn. (Courtesy Scott Camazine)



**Figure 38.** Scale of American foulbrood showing remains of pupal tongue. (Courtesy Scott Camazine)

Only a few dead larvae or pupae will be seen when the colony is first infected by the disease. Once established though, AFB spreads rapidly through the brood area. If left unchecked, AFB can be transmitted quickly to other healthy colonies at the same location and even to nearby apiaries.

Nurse bees within the hive inadvertently feed honey contaminated with spores to young larvae, which perpetuates the disease. As the number of brood cells increases with the scales of dead larvae, which are spore reservoirs, housecleaning bees also aid in spore dispersal. Honey supplies within the brood chamber soon become contaminated as honey is stored in these spore-laden cells. Bees also transfer honey from the brood chamber to the supers above, thus spreading disease throughout the entire hive.

As the infection weakens a colony, the colony can no longer defend itself against robbers from strong colonies in the area. Spore-contaminated honey is spread quickly from hive to hive.

American foulbrood is also transmitted through the interchange of combs between hives. When this disease is not recognized in an apiary, combs from a diseased hive inadvertently may be: (1) used in making splits or increases, (2) used in exchanging brood and food between hives, and (3) mixed with combs from other hives during honey extraction. In addition, the beekeeper's hive tool and gloves may spread AFB from hive to hive.

American foulbrood spores are highly resistant to desiccation, heat, and chemical disinfectants. These spores can remain virulent for more than 40 years in combs and honey. Therefore, honey should not be purchased from other sources to feed bees. Only feed combs of honey if you are absolutely sure they are disease free. An inexperienced beekeeper should not buy bees or equipment that have not been examined by an inspector or someone else familiar with the disease. Even a stray swarm from an infected colony may carry AFB. American foulbrood cannot be transmitted to humans and has no effect on honey for human consumption.

Because of the highly contagious and devastating action of the disease, every beekeeper should know the symptoms and be able to recognize AFB in its early stages. If you suspect disease and need help in diagnosis, contact your state apiary inspection service (see appendix or consult the MAAREC Web site: [maarec.cas.psu.edu](http://maarec.cas.psu.edu)).

Samples of diseased comb for laboratory diagnosis can be sent to:

BELTSVILLE BEE RESEARCH LABORATORY  
BUILDING 476 BARC-EAST  
BELTSVILLE, MD 20705

To send samples for diagnosis, select a sample of brood comb about 4 inches square that contains a large number of suspect cells. The section of comb can be wrapped in some type of breathable material such as tissue or paper towel and mailed in a strong cardboard box. Do not use aluminum foil or plastic bags. Samples that are crushed, wet from condensation, or moldy because of improper packaging make diagnosis impossible. Another alternative is to send a smear of the contents of the suspect cells in aluminum foil.

Colonies infected with American foulbrood should be destroyed by burning. Burning the bees and all of the equipment is the only sure way to be absolutely free of this disease. The bottom board, hive bodies, supers, and inner and outer covers can be disinfected and reused. However, there is no guarantee that the equipment can be completely sterilized, and the disease may reappear. Before burning, diseased colonies should be killed in the evening after all foraging activities have ceased. This can be done by drenching the bees in the colony with soapy water. Burning bees and equipment found to be infected with antibiotic-resistant AFB is highly recommended and even mandatory in some Mid-Atlantic States.

To burn diseased equipment, dig a pit 18 inches deep and wide enough to hold all combs and equipment to be burned. Build a fire in the pit. Set your unopened hive close to the pit and drop all combs and dead bees into the fire. After everything has been completely burned and the area cleaned of small pieces of comb or bees, cover the ashes with dirt.

Equipment that was saved (bottom boards, hive bodies, and covers) should be scraped to remove all propolis and wax, then scrubbed with a stiff brush and hot, soapy water. Dispose of the wash water and burn the scrapings so they are not accessible to the bees. After scraping and scrubbing, all equipment should be either fire scorched or completely immersed in a boiling lye solution. Prepare your lye solution (sodium hydroxide) by mixing 1 pound of lye with 10 gallons of water. Boil the equipment for

20 minutes; wooden parts can be damaged by longer exposure. Weaker solutions may not remove all of the wax and propolis from the equipment. Remember that lye solutions are caustic and can cause severe burns. Before using, read the label carefully and observe all precautions.

A blowtorch is suitable for scorching small quantities of equipment. Burn the surface until it is light brown, making sure to include the corners. For large quantities of hive bodies, brush the inside surfaces with kerosene. Stack the hive bodies with the metal rabbets facing downward on top of each other, five to eight supers high, and then ignite the stacks, allowing them to burn long enough to lightly char the wood. Another approach is to fill the stack with wadded sheets of newspaper sprinkled with kerosene. Place an outer cover on top of the stack to smother the fire when you are finished.

Antibiotics such as Terramycin® (oxytetracycline HCL) have been used as a preventive measure as well as a treatment against American foulbrood. These antibiotics do not kill *Paenibacillus larvae* spores but prevent or delay their growth when present in low concentrations in the food fed by workers to susceptible larvae. While this treatment allows individual larvae to survive, it does absolutely nothing about the virulent spores in the contaminated equipment. Thus, the disease usually reappears once drug feeding stops. In addition, increasing numbers of colonies and whole beekeeping operations are being found infected with AFB that is resistant to the antibiotic Terramycin. New antibiotics are being investigated for treating foulbrood. However, inevitably over time these too will have reduced effectiveness due to the inherent ability of diseases to develop resistance to drugs.

For detailed information on approved chemicals for treating American foulbrood and their use, see the appendix or visit the MAAREC Web site: [maarec.cas.psu.edu](http://maarec.cas.psu.edu). If you do not have Internet access, contact your local cooperative extension office.

**CAUTION:** Do not feed antibiotics to your colonies when there is any danger of contaminating the honey crop. All drug feeding must stop at least 6 weeks before any surplus honey flow. Every precaution should be taken to ensure that no antibiotic will ever be present in honey taken from the hive.

## EUROPEAN FOULBROOD

European foulbrood (EFB), another bacterial brood disease, is caused by *Melissococcus pluton*. This disease is considered a stress disease and is most prevalent in spring and early summer—the period when brood rearing is at its height, although the earliest brood is rarely affected. European foulbrood frequently begins to disappear with a nectar flow and may disappear entirely for the balance of the year; or it may reappear during nectar dearths in the summer or fall. Occasionally, the disease remains active throughout the entire foraging season. All castes of bees are susceptible; commercial strains differ in susceptibility.

The disease and its symptoms are highly variable, probably because several other types of bacteria are often present in dead and dying larvae. EFB usually does not kill the colony, but a heavy infection will seriously reduce population development. European foulbrood generally kills larvae 2 to 4 days old while they are still coiled in the bottom of the cells (Figure 39). Unlike American foulbrood, most of the larvae die before their cells are capped. A spotty pattern of capped and uncapped cells develops only when EFB reaches serious proportions. Occasionally, pupae die from the disease.

The most significant symptom of EFB is the color change of the larvae. They change from a normal pearly white to yellow, then brown, and finally grayish black. Larvae also lose their plump appearance and look undernourished. In such cases, larval remains appear twisted or coiled in the bottom of the cell (Figure 40, next page). They form a thin brown or blackish-brown scale and show distinct lines where their breathing tubes are located.

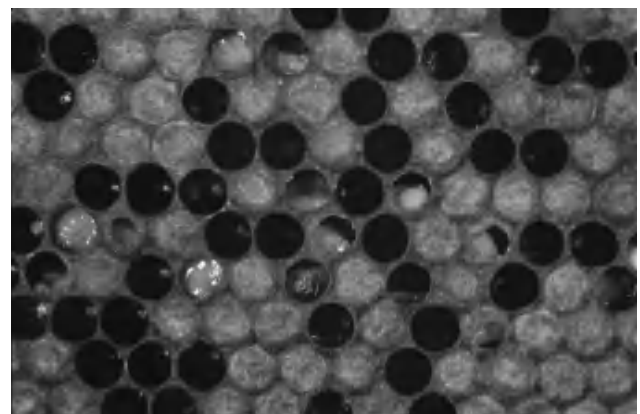

**Figure 39.** Larvae infected with European foulbrood. (Courtesy Maryann Frazier)

Recently dead larvae are rarely ropy. Scales can be removed easily from the cells because they do not adhere tightly to the cell as in American foulbrood. Bees remove the scales under the stimulus of a nectar flow or feeding.

*Melissococcus pluton* does not form spores, but the organism often overwinters on combs. It gains entry into the larva in contaminated brood food and multiplies rapidly within the gut of the larva. Not all infected larvae die from the disease. Some develop normally and void the germ or regurgitate the bacteria onto the underside of the cappings, which then become sources of the disease.

In some cases, European foulbrood can be eliminated by requeening colonies with a young queen. Requeening accomplishes two things: it gives the colony a more prolific queen and it permits a time lag between brood cycles that allows the house bees to remove diseased larvae from their cells. Antibiotics such as Terramycin have been used to treat this disease.

For detailed information on approved chemicals for treating European foulbrood and their use, see the appendix or visit the MAAREC Web site: [maarec.cas.psu.edu](http://maarec.cas.psu.edu). If you do not have Internet access, contact your local cooperative extension office.

**CAUTION:** *Do not feed antibiotics to your colonies when there is any danger of contaminating the honey crop. All drug feeding must stop at least 6 weeks before any surplus honey flow. Every precaution should be taken to ensure that no antibiotic will ever be present in honey taken from the hive.*

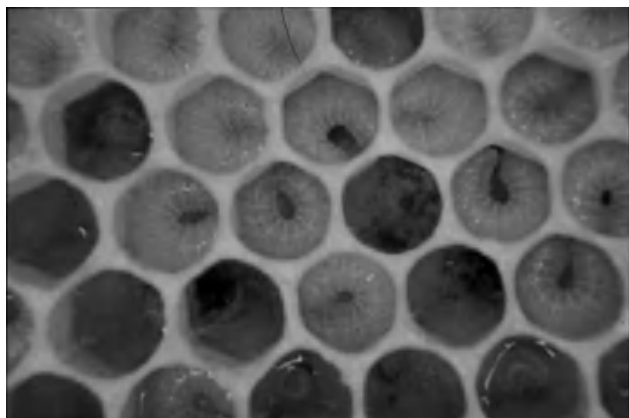

**Figure 40.** European foulbrood advanced; larva twisted in cell. (Courtesy Dewey Caron)

## SACBROOD

This disease, caused by a virus, does not usually cause severe losses. It is most common during the first half of the brood-rearing season and often goes unnoticed since it usually affects only a small percentage of the brood. Both worker and drone larvae are affected. Pupae may be killed occasionally, whereas adult bees are immune to it. Death usually occurs after the cell is sealed and the larva has spun its cocoon. Dead brood is often scattered among healthy brood. The cappings over dead brood are first punctured and later removed by the bees. The larvae gradually change from pearly white to dull yellow or gray and finally to black. The head of the larva, the first part of the body to change color, becomes black. Larvae die in an upright position with raised heads (Figure 41). Diseased

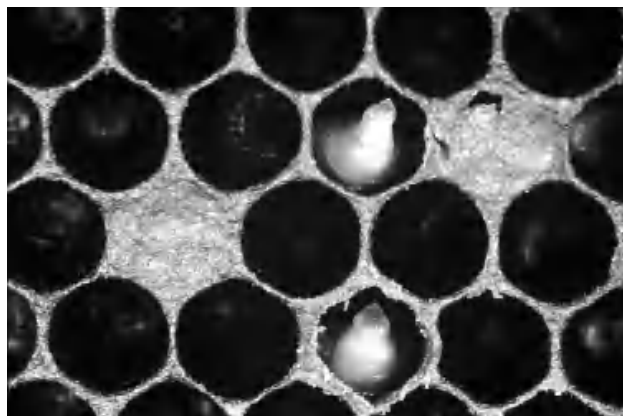

**Figure 41.** Dead larva infected by sacbrood with typical darkened, raised head. (Courtesy Scott Camazine)



**Figure 42.** Larva infected with sacbrood that has been removed from the cell. Note the sac-like appearance of the larva when removed. (Courtesy Scott Camazine)

larvae are easily removed intact from the cells, unlike those afflicted with American foulbrood. The contents of the larvae are watery, and the tough outer skin appears as a sack or bag of fluid when suspended (Figure 42). The dried scale lies flat on the lower side of the cell, with the head end raised and the tail flat on the bottom of the cell. The scales are rough and brittle and do not adhere tightly to the cell wall.

Nurse bees are suspected of transmitting the disease by carrying the virus from cell to cell. It is also believed that robber bees spread the disease by carrying contaminated honey from colony to colony.

Sacbrood usually disappears in the late spring when the nectar flow has started. Strong colonies and regular requeening seem most effective in combating this disease. No antibiotic is effective in preventing or controlling sacbrood.

### CHALKBROOD

Chalkbrood is a fungal brood disease of honey bees caused by the spore-forming fungus *Ascosphaera apis*. Worker, drone, and queen larvae are all susceptible. Dead larvae are chalky white and usually covered with filaments (mycelia) that have a fluffy, cotton-like appearance (Figure 43). These mummified larvae may be mottled with brown or black spots, especially on the ventral sides, due to the presence of spore cysts or fruiting bodies of the fungus.

Diseased larvae can be found throughout the brood-rearing season but are most prevalent in late spring when the brood nest is rapidly expanding. Chalkbrood usually disappears or declines as the air temperature rises in the summer. Affected larvae are found on the outer fringes of the brood nest where there are too few nurse bees to maintain brood nest temperature. Brood cells can be either sealed or unsealed. Young pupae or recently sealed larvae are most susceptible. Infected larvae, stretched out in their cells, are removed by nurse bees 2 to 3 days after symptoms first appear. Dead larvae (mummies) are often found in front of the hive, on the bottom board, or in the pollen trap (Figure 44). In strong colonies, most of these mummies will be discarded by worker bees outside of the hive, thus reducing the possibility of reinfection from those that have died from the disease.

Spores of the fungus are ingested with the larval food. The spores germinate in the hind gut of the bee larva, but mycelial (vegetative) growth is arrested

until the larva is sealed in its cell. At this stage, the larva is about 6 or 7 days old.

The mycelial elements break through the gut wall and invade the larval tissues until the entire larva is overcome; this process generally takes from 2 to 3 days.

Spores remain virulent for years. Therefore, infected pieces of equipment, especially brood combs, are a reservoir for further infection. Chalkbrood usually does not destroy a colony. When the disease is serious, however, it can prevent normal population buildup and surplus honey production. Research has shown that the spores are easily passed from bee to bee. Therefore, drifting and robbing bees are potential vectors of the disease. Both workers and queens taken from infected colonies can transmit infection to healthy colonies. Colonies fed pollen collected from infected colonies will also contract the disease.

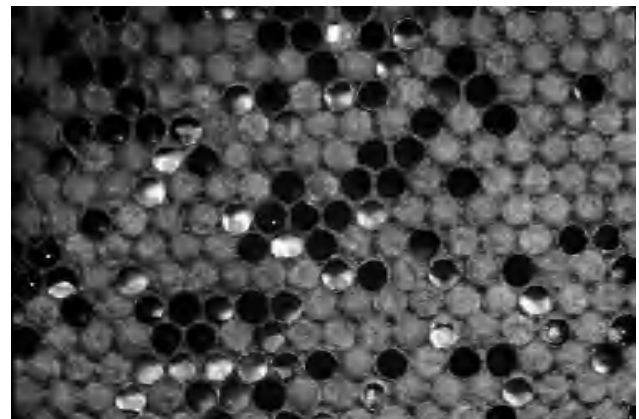

Figure 43. Worker larvae infected with chalkbrood. (Courtesy Scott Camazine)



Figure 44. Chalkbrood "mummies" removed by workers and dropped at hive entrance. (Courtesy Maryann Frazier)

Chalkbrood infections are not always visible in the brood nest. Therefore, beekeepers who collect pollen to sell or to feed to their bees should check the pollen and pollen traps from each colony for whole mummies or mummy parts. No treatment is presently available for control. However, colonies with persistent cases may benefit from requeening, particularly with hygienic stock.

### STONEBROOD

Stonebrood is also a fungal disease. Several fungi belonging to the genus *Aspergillus* are associated with the disease, the most common being *A. flavus* and *A. fumigatus*. However, *A. flavus* is considered, by far, the most important.

Both larvae and pupae are susceptible. The disease causes mummification of the infected brood. Mummies are hard and solid, not sponge-like as in the case of chalkbrood. Brood infected by *A. flavus* become covered with a powdery green growth of fungal spores. The spores are found most abundantly near the head of the affected brood.

This disease is considered of minor importance and is rarely encountered. No treatment is recommended. The bees remove the dead brood on their own and the colony normally recovers in a short period of time.

### PARASITIC MITE SYNDROME (PMS)

For the past several years, we have been seeing diseased bee larvae with symptoms resembling a cross between foulbrood and sacbrood. The USDA Beltsville Bee Lab has found these diseased larvae to be infected with one, or commonly several, viruses. This situation is associated with varroa mites. The complex of symptoms has been given the name "Parasitic Mite Syndrome" or PMS.

Affected larvae die in the late larval or prepupal stage, stretched out in their cells often with their heads slightly raised (Figure 45). In the early stage of infection, they are white but dull rather than glistening, and they look deflated. Later, the larva may have gray or brownish spots. Prepupae die after the cell has been capped, and the cappings may be perforated or completely removed by the bees. When the larval remains are stirred with a toothpick or small twig, they do not rope out but are globular (similar to European foulbrood).

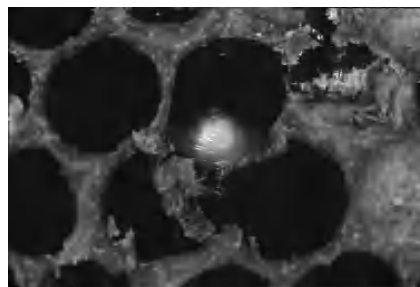

**Figure 45. Virus-infected larva.**  
(Courtesy Maryann Frazier)

Since the virus complex is associated with varroa mites, controlling varroa is important in combating or at least controlling these viruses. Because many infected colonies seem to collapse in early fall, dealing with mite populations well before this time is necessary. Please see information under "Varroa Mite" for details on managing these mites in honey bee colonies.

Several years of survey data collected in the MAAREC region indicate that beekeepers treating varroa mite-infested colonies in autumn with fumagillin (Fumidil-B®) significantly improved colony winter survival. Fumagillin fed in sugar syrup is used to suppress nosema disease in overwintered colonies and newly established packages. Nosema disease weakens the digestive tracts of infected bees and may allow pathogens to enter the honey bees' guts where they can cause significant damage. Treating colonies in fall with fumagillin might help to protect bees from some of the pathogens associated with varroa mites, thus improving their chances of survival. Please see "Nosema" and the appendix at the back of this book for more information on treating colonies with fumagillin.

## Diseases of Adult Bees

### NOSEMA

Nosema disease, an obscure killer, is caused by a spore-forming protozoan (*Nosema apis*) that invades the digestive tracts of honey bee workers, queens, and drones. Spores of the disease are ingested with food or water by the adult bee. The spores germinate and multiply within the lining of the midgut. Millions of spores are shed into the digestive tract and eliminated in the feces. Damage to the digestive tract may produce dysentery and weaken the bees. As a result, the productive life of the worker is shortened and its ability to produce brood food decreases, thus retarding brood production and



colony development. When queens become infected, egg production and life span are reduced, leading to supersedure. Infected workers, unlike healthy workers, may defecate in the hive. Diseased colonies usually have increased winter losses and decreased honey production. The loss of queens in colonies newly started from package bees is the most serious effect of the disease.

Even though nosema is a common disease of bees, it generally goes unnoticed in the apiary since it does not produce signs or symptoms that are easily recognized under field conditions. In fact, the presence of the disease is not usually realized until most of the bees in the colony are infected. The only positive way of identifying the disease is through dissection of adult bees. The hind gut and digestive tract of diseased bees are chalky white or milky white. Healthy bees, on the other hand, have amber or translucent digestive tracts. In addition, individual circular constrictions of a healthy bee's gut are visible, whereas the gut of an infected bee may be swollen and the constrictions not clearly visible. Infection is best detected by the microscopic examination of macerated abdominal tissue for the presence of spores.

Nosema disease is most prevalent in the spring. Severity of infection varies among colonies, geographic regions, and from year to year. In overwintered colonies, confined infected bees may defecate on the combs and infect healthy bees as they clean the combs in the spring. Food stores and soiled shipping cages are other sources of infection. Spores are spread by infected package bees, splits, and contaminated equipment. Combs from weakened colonies that died during the winter often have nosema-contaminated feces. Installation of packages or divisions on this equipment in the spring hampers colony development and often results in queenlessness.

Queens may become infected from various sources after they emerge from the queen cells or are released in mating nuclei. When the disease is severe, colony populations may become depleted and eventually dwindle to a handful of bees and a queen. This is often referred to as "spring dwindling." In colonies that are only mildly affected, brood rearing eventually allows the colony to recover.

Colony confinement during winter or inclement weather in the spring encourages nosema disease buildup. Winter cleansing flights enable bees to

defecate outside, thus preventing spore contamination within the cluster. Nosema-sick bees often fly from the hive at marginal flight temperatures, probably because they are under stress. Since they are weak, they drop to the ground, become chilled, and are unable to return to the colony. Sick bees are thereby eliminated from the colony. The intensity of infection usually subsides in April as field flights begin and brood emergence accelerates.

Brood emergence, the colony's primary natural defense against nosema, replaces infected bees with young healthy bees. If nosema is already present, any break in the brood-rearing cycle will likely increase the incidence of the disease, especially in early spring. Newly hived package bees are very susceptible to nosema. During the first 3 weeks following installation, when the colony has no emerging young bees, the disease can spread rapidly through the old adult population and to the queen.

The best defense against nosema is to winter only strong colonies with plenty of honey in the proper position and with young vigorous queens. Many different chemicals have been tested for control of the disease, but only Fumidil-B® (fumagillin) has proven effective. Fumagillin is especially effective in suppressing nosema in overwintered colonies and newly established packages. However, since fumagillin does not affect spores of the nosema parasite, treatment with this drug will not completely eliminate the disease from the colony.

For detailed information on using fumagillin for the treatment nosema disease, see the appendix or visit the MAAREC Web site: [maarec.cas.psu.edu](http://maarec.cas.psu.edu). If you do not have Internet access, contact your local cooperative extension office.

**CAUTION:** *No medication should be fed to colonies when there is danger of contaminating the honey crop. Be sure to stop feeding fumagillin at least 4 weeks before the onset of the honey flow.*

## **PARALYSIS**

Paralysis, a minor disease of adult honey bees, is usually associated with virus. Two different viruses, chronic bee paralysis virus (CBPV) and acute bee paralysis virus (ABPV), have been isolated from paralytic bees. Other suspected causes of paralysis include pollen and nectar from such plants as buttercup, rhododendron, laurel, and some species of basswood; deficient pollen during brood rearing

in the early spring; and consumption of stored fermented pollen.

Bees affected by this disease tremble uncontrollably and are unable to fly. In addition, they lose the hair from their bodies and have a dark, shiny, or greasy appearance. Often mistaken for robber bees, infected bees are submissive to attack whereas robbing bees are not. When paralysis is serious, large numbers of infected bees can be found at the colony entrance, crawling up the sides of the hive and blades of grass, and tumbling to the ground. Healthy bees often tug at these bees in an effort to drive them away from the hive.

A colony may recover from paralysis after a short time, or the condition may continue for a year or more without killing the colony. Usually only one or two colonies in an apiary will show signs of the disease. Research has shown that susceptibility to the disease is often inherited. If paralysis persists, colonies should be requeened with a different strain of bees. Adding a frame or two of sealed brood from a healthy colony to build up the number of young bees in the diseased colony is also helpful.

### DYSENTERY

Dysentery, a condition rather than a disease, is caused by an excessive amount of water in a bee's body. Afflicted bees cannot hold waste products in their bodies. Unable to wait until cleansing flights, these bees void their feces on the combs, at the hive entrance, on the exterior of the hive, and on the snow near the hive in late winter. Two leading causes of dysentery are prolonged confinement during winter and early spring and consumption of food with high water content. Nosema disease and damp hives may also contribute to the problem.

To prevent dysentery, make sure hives are well ventilated and stocked with high-quality food. If fall feeding is necessary, do it early enough so that the bees can properly ripen their stores.

## Parasitic Mites

### VARROA MITE

The varroa mite, *Varroa destructor*, is considered by many to be the most serious malady of honey bees. It now occurs nearly worldwide. This external parasite feeds on the hemolymph (blood) of adult bees, larvae, and pupae. Heavy parasitism results in

heavy bee mortality and subsequent weakening of the colony and can lead to colony death. This is especially true if certain viruses are present and being transmitted by varroa mites.

This mite is an external parasite visible to the naked eye. The female mite is brown to reddish-brown in color and is about the size of a pinhead. Males are slightly smaller and light tan in color. Adult males do not feed and are not found outside of brood cells.

Adult female mites can live outside the brood cells and are primarily found on adult drone and worker bees (Figure 46). This behavior allows them to invade new host colonies and survive the winter in these colonies. The flattened shape of the female's body makes it easy for the mite to hold onto a bee and move easily into the cells of developing bee brood. When on adult bees, female varroa are found mainly on the top of the bee's thorax at the point where the wings attach, between the head and the thorax, between the thorax and the abdomen, or between overlapping segments of the abdomen. These are places where the mites can easily use their piercing mouthparts to penetrate the exoskeleton of their host and gain access to the bee's hemolymph. These are also places where mites are less likely to be removed by the bee's grooming.

When female mites are ready to lay eggs, they move into brood cells containing young larvae just before the cells are capped. They go to the bottom of the brood cells and immerse themselves in the remaining brood food. After the cells are capped and the larvae have finished spinning cocoons, the mites start feeding on the larvae. They begin laying eggs approximately 3 days after the cell has been capped.



**Figure 46. Varroa mites on adult worker bee. Note deformed wings on this newly emerged adult worker. (Courtesy Maryann Frazier)**

A fertilized female mite lays a total of four to six eggs. The adult female and its immature offspring feed and develop on the bee as it matures.

After hatching from the egg, the immature mite passes through several developmental phases including the eight-legged protonymph and deutonymph stages. The period from egg to adult takes about 6 to 7 days for the female and 5 to 6 days for the male.

Mating occurs in the brood cells before the new adult females emerge. The adult males die after copulation since their mouth parts (chelicerae) are modified for sperm transfer rather than feeding. The old female and the newly fertilized female offspring remain in the brood cell until the young bee emerges. The adult bee serves as an intermediate host and a means of transport for these female mites.

More mite offspring can mature during the longer development time (capped period) of the drones. (See Table 1 on page 5.) However, worker brood also is attacked. Queen brood is attacked only in cases of heavy infestation. Female mites produced in the summer live 2 to 3 months, and those produced in the fall live 5 to 8 months. Without bees or capped brood, the mites can survive no more than 5 days. We do not know precisely how varroa mites spread so rapidly. We do know that these mites can be spread by the movement of honey bee colonies (migratory beekeeping), the shipment of queens and package bees, and the movement of colonies for pollination rentals. Beekeepers probably spread an infestation from one colony to another through normal apiary manipulations. Infestations also are spread as a result of drifting (especially drifting drones) and swarming bees.

Individual developing bees, if infested with one to two adult mites (and offspring), may emerge without visible damage and are usually normal in appearance. They may, however, suffer from malnutrition, blood loss, or disease. Individuals heavily infested with more than five adult mites (which produce as many as 20 nymphs) usually become visibly crippled or die in their cells without emerging. How much of this damage is due to the feeding of mites versus the introduction of viruses is not known. When adult bees are infested with two or more mites, they become restless, fly with difficulty, their life span is generally shorter compared to unparasitized bees, and they perform tasks poorly.

On a colony level, the symptoms of a varroa mite infestation depend on the degree of infestation and the presence of certain viruses. Low-level varroa infestations are difficult to detect. Medium- to high-level infestations may result in the appearance of a spotty brood pattern, as well as the presence of malformed worker and drone adults with deformed wings (may be associated with deformed wing virus) and small abdomens. Such bees are often unable to fly and can be seen crawling. Bees will uncap and throw out infested brood, which can sometimes be found at the hive entrance. Parasitized pupae will appear to have small, pale or dark-reddish brown spots (mature and possibly immature mites) on their normally white bodies. Colonies can become severely debilitated as mite populations reach extremely high levels at the end of the brood-rearing season, especially if certain viruses are present.

Control of these mites to date has been largely via chemical means. Plastic strips impregnated with a chemical pesticide have been used throughout the United States. These strips deliver a contact pesticide, which means that the mites must come in contact with the strips in order for the material to be effective. However, mites have quickly developed resistance to these chemicals, making them useless in a relatively short period of time.

Due to our lack of success controlling mites with chemicals and our increasing concerns about the risks associated with chemical contamination of honey, we have come to realize that the long-term solution to controlling parasitic mites must be based on an understanding of the host bees, the mites, and their relationship.

### **Integrated Pest Management (IPM)**

Once varroa mites were introduced into North America, beekeepers were faced with damaging levels of these mites, so they quickly adapted to using the pyrethroid pesticide fluvalinate (Apistan®) on a routine basis; many commercial beekeepers began using it twice annually. As an industry we accepted this “solution” without understanding the “problem”—in part because the chemical control, Apistan, was relatively inexpensive, handy to use, and had a wide margin of safety. Small amounts of the pesticide killed mites without harming bees or being retained in bee products and were relatively safe for the applicator to handle.

Beekeepers developed the habit of using chemical pesticides as a preventative measure rather than attempting to determine which colonies actually needed treatment. Overuse, misuse, and near total reliance on pesticides eventually led to the mites developing resistance to fluvalinate, thus making it useless. The replacement miticide, the organophosphate coumaphos (Checkmite +®), was not nearly as forgiving as Apistan; it is potentially more toxic to the bees, accumulates more readily in beeswax, and is not as safe for the applicator to handle. Mites have become resistant to this second chemical as well.

Beekeepers are coming to the realization that the solution to mite control may not be as simple as applying a pesticide. The better solution is managing mite populations using biological means as the first and primary line of defense. This approach, called **Integrated Pest Management (IPM)**, has been widely adopted by many other agricultural commodity groups. IPM of bee mites is based on an understanding that some mites can be tolerated by colonies. The goal is not the elimination of every single mite but rather the **management** of mite (**pest**) populations by keeping them below a level that will cause damage to the colony by combining (**integration**) a variety of control tactics (Figure 47). In an IPM approach, chemical controls are not eliminated, but they are used as the tool of last resort and only when other control tactics have failed to keep mites levels below threshold. Adopting an IPM approach can be considered analogous to making a

soup—a soup may be made with only a single ingredient, but usually the “best” soups consist of several ingredients. Similarly, mite control could be a single-source “soup” (only use a pesticide) or it could be a more varied “soup” by using a variety of IPM control approaches.

**Principles of IPM**

- Decision-making process based on understanding the pest, the host, and their interactions
- Based on thresholds
- Uses multiple tactics
- Must be safe, profitable, and environmentally friendly

Central to IPM is the identification of a threshold, the number of pest below which the host can tolerate but above which action must be taken to prevent damage or loss. Knowing the threshold and the size of the mite population in a colony (or in the apiary) by using a sampling method then allows:

1. treating only colonies (or apiaries) that need treatment (beekeepers save money and reduce collateral damage by only treating colonies that need treatment and not spending money to treat colonies that do not need treatment), and
2. evaluation of the effectiveness of IPM mite suppression techniques to keep the mite population below a harmful level (threshold).

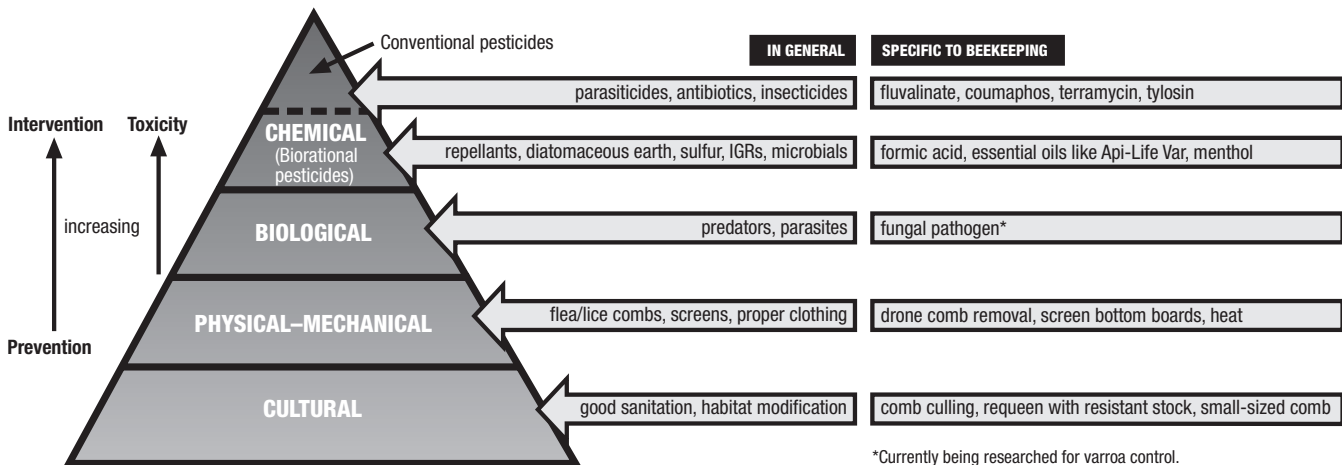

Figure 47. Pyramid of IPM tactics. (Courtesy the PA IPM program)

### Steps in Implementing IPM

- Identify Problem
- Determine Threshold
- Assess Options
- Select and Apply Controls
- Evaluate Success and Record Results

#### *Identify the Problem.*

There are several ways for detecting and monitoring varroa mite infestations. A visual inspection of adult bees can tell you if mites are present. Another technique is to examine brood for the presence of mites. Uncap and examine sealed brood, especially drone brood. Individual pupae can be removed with forceps to permit visual inspection. A faster technique utilizes an uncapping fork to remove many drone pupae for close examination (Figure 48). A small 10x hand lens will help considerably. But unless infestations are very high, these techniques can tell you little about the level of mites in a colony.

The ether-roll is a quick, relatively easy sampling method to check for the presence of mites. Brush approximately 500 bees from the brood nest (1 inch deep) into an empty glass jar such as a quart-size, wide-mouth canning jar. Close the lid and tap the jar to knock the bees to the bottom. Add a 1- or 2-second squirt of an ether-based aerosol starter fluid (the type used to start cars in cold weather). The ether will kill the bees and cause the mites to fall off the adult bees. Shake the jar of bees hard for 15 to 20 seconds, then turn the jar on its side and gently roll it. If present, mites will adhere to the sticky film left on the sides of the jar. Light infestations may be missed by this



**Figure 48.** Drone pupae being removed with an uncapping fork for varroa mite examination. (Courtesy Maryann Frazier)

method. An alternative to the ether-roll is the powdered sugar-roll. This technique is somewhat similar to the ether-roll but has the advantage of not killing the bees. To use this method you will need a glass jar as described above fitted with a two-piece canning jar lid. Retain the metal ring, and discard the center portion. Cut a circle of 8 mesh hardware cloth and fit it inside the ring. Then brush approximately 500 bees (1 inch deep) into the jar. Add enough powdered sugar to coat the bees, about 2 tablespoons (use more in humid weather), and shake the jar vigorously for approximately 30 seconds, then invert the jar and shake mites and sugar onto a piece of white paper. The bees will remain in the jar, and the mites and sugar will pass through the screen. The mites will appear as tiny reddish-brown specks on the paper. The lid of the jar can then be removed and the bees returned to the hive. Take care not to dump the bees and sugar directly onto frames of open brood because powdered sugar can suffocate larvae.

For various reasons, varroa mites are constantly falling to the hive bottom board. Thus, bottom board examination can be used to assess mite presence and/or monitor mite levels. A piece of white cardboard placed on the bottom board makes spotting the mites in the debris easier. The white cardboard should be covered with a piece of wire screen (8 mesh/inch hardware cloth) to prevent the bees from removing fallen mites. Space the screen  $\frac{1}{4}$  inch above the white cardboard by stapling continuous strips of corrugated cardboard around the edges. To aid in trapping mites, sticky materials such as petroleum jelly, Tanglefoot®, or vegetable oil can be applied to the white cardboard; in these cases, you must use a screen to keep the bees from getting stuck. Research has shown that obtaining a natural mite fall by leaving these boards in colonies for 3 days, then counting the mites on the board and dividing by three to determine a natural mite drop per day can provide valuable information about the levels of mites in hives, especially if mites are monitored this way throughout the season. Sticky boards can be homemade, as described above, or purchased from IPM Technologies, 4134 N. Vancouver Ave., Portland, OR 97217 or Great Lakes IPM, 10220 Church Road, Vestaburg, MI 48891. The latter is a special sampling board developed by Penn State researchers and is based on a subsampling scheme that requires counting only a portion of the board to get the natural mite drop per day.

### **Determine Threshold.**

Research at the University of Delaware and other universities indicates that in general if more than 50 mites per day (threshold) are collected on a sticky board, the decision to treat is warranted. While a natural mite drop of 50 mites per day on sticky board in late summer is considered a reasonable threshold for treatment, individual beekeepers may choose to adjust this threshold up or down depending on their individual circumstances. If you are concerned about applying chemical pesticides and are willing to take increased risk of losing colonies, you might increase this threshold. If, on the other hand, you want to reduce the risk of losing colonies and are not concerned about applying pesticides, you may decrease this threshold. Other factors might come into play when identifying treatment thresholds such as additional stresses on colonies including viruses and poor environmental conditions.

### **Assess Options.**

One of the best mite management “tools” available to us is bee stock that is more resistant (less susceptible) to mite damage. Importing Russian bees and developing SMR (suppressed mite resistant) bees by USDA and hygienic queen stock by University researchers and bee breeders are initial efforts toward the goal of maintaining productivity in spite of mite pressure. Under light population pressure some stocks (such as the Russian bees released by USDA to bee breeders and hygienic bees) have the ability to coexist with varroa. Most stock still will suffer or die from heavy varroa mite infestations. Good IPM mite control should begin with the use of mite-resistant bee stock.

Since drone brood is more heavily infested than worker brood, reducing varroa populations by periodically removing mite-infested drone brood from colonies is possible. Frames of drone comb—acquired by purchasing drone foundation or using frames without foundation in which bees will construct drone cells or  $\frac{1}{2}$  depth frames in standard-depth hive boxes below which bees will construct drone cells—placed into the brood area of colonies during the early part of the season will stimulate workers to draw drone cells and attract queens to lay unfertilized eggs. After the cells of the drone pupae are capped, remove these frames from the colony and kill the developing brood (with mites inside the cells) by freezing. The technique is

especially effective in the early spring when varroa are concentrated on small patches of drone brood. After brood and mites are killed (1–3 days in freezer), the comb can be discarded or the drone pupae removed (uncap cells and sharply jar frame to dislodge dead pupae) and the frame returned to the colony to trap additional mites.

Varroa also can be trapped on sticky boards or bottom boards modified so the mites are isolated from the bees. Since 40 percent or more of the mites that fall to the bottom board are alive, trapping these mites and removing them from the colony on a regular or continuing basis can help to reduce varroa populations. Special screened bottom boards or screen inserts (8 mesh/inch hardware cloth) suspended at least  $\frac{1}{2}$  inch above the bottom board allows the mites to fall completely out of the colony and reduces the overall varroa population buildup. Some beekeepers are simply eliminating bottom boards or replacing solid bottom boards with screened ones.

The use of a smaller foundation cell size has also been found to be effective in reducing varroa mite numbers, at least with bee stock (such as Africanized bees in the southwestern United States) that readily accepts the smaller cells.

Mites are also killed by exposure to heat 104–110°F (40–43°C) for 4 hours. This might be effective for bees held in packages for shipment, or if the entire bee population is removed from the colony and treated. But it will not kill the majority of the mites sequestered within the capped brood cells.

Location of apiary sites may play a role in mite buildup. Early research suggests that sites with more air drainage may assist in suppressing mite numbers. Using mineral oil or grease patties in hives might also help keep mite numbers reduced.

A wide range of chemicals have been tested for their ability to harm or kill mites. To be utilized, such chemicals must not harm the bees or leave a potential residue behind and must be safe for the beekeeper to handle.

Formic acid was registered in the United States in 1999 for control of tracheal mites and the suppression of varroa populations. The difficulty with this naturally occurring acid, and several others that have mite-killing activity such as acetic (vinegar), lactic, and oxalic acids, is delivery of an effective concentration that is safe for the applicator and not harmful to the bees. Formic acid gel packs were

formulated and briefly on the market but were then recalled due to faulty packaging and concerns about applicator/colony injury. Several delivery devices are used in Europe and Canada, and some U.S. beekeepers have adapted these for their own use. These materials are dangerous and can cause severe burns to the applicator and in concentrated forms are potentially harmful to the bees. Commercial bee supply companies are working on packaging to allow wider use.

A number of essential oils have been shown to be effective mite control agents. These include white thyme, thymol, citronella, clove, origanum, camphor, rosemary, and others. One commercial product, Api-Life Var® (a mixture of eucalyptol, menthol, and camphor), is used in Europe, and several U.S. states have received emergency-use registration. The delivery of such concentrates remains problematic to ensure that enough of the material is present for a sufficiently long enough time period to reduce mite populations. Likewise, mineral and vegetable oils and some drying agents (talc, diatomaceous earth) will reduce mite populations, but proper dosage and timing is not yet practical. Some of these are fed to the bees and others are placed in the colony so the bees work to remove the (offensive) compounds.

Natural product smoke, produced by adding tobacco, sumac heads, fresh grapefruit leaves, and other materials in the smoker, have been demonstrated to cause mites to fall off of bees. Some of these materials are harmful to bees and potentially to the applicator, especially with repeated or prolonged exposure. Mites may not be killed with such compounds and may need to be trapped at the bottom of treated hives. None are effective on mites within capped brood cells.



**Figure 49. Tracheal mites released from trachea. Taken under magnification. (Courtesy Scott Camazine)**

Effective materials for varroa mite control are rapidly changing. For the most current information on registered chemicals and their use for treating varroa mite, visit the MAAREC Web site: [maarec.cas.psu.edu](http://maarec.cas.psu.edu). If you do not have Internet access, contact your local cooperative extension office.

### **HONEY BEE TRACHEAL MITE**

*Acarapis woodi*, the honey bee tracheal mite, infests adult honey bees. This internal parasitic mite lives within the tracheae, or breathing tubes, inside the thorax of adult honey bees (Figure 49). Mites also may be found in air sacs in the thorax, abdomen, and head. The mites pierce the breathing tube walls with their mouth parts and feed on the hemolymph of the bees. As a result of mite feeding, the hemolymph of infested bees has a higher-than-normal bacterial count. This disease shortens the lives of adult bees, affects flight efficiency, and causes a large number of crawling bees that are unable to fly.

As mite populations increase, colony populations dwindle, and this ultimately results in the death of the colony. Colonies are most affected during winter confinement and early spring like a stress disease. Mite infestations are at a maximum in the spring when the population is composed of primarily older bees.

The honey bee tracheal mite is difficult to identify and study because of its small size; the female is no bigger than a dust speck. Under magnification, the body is oval, widest between the second and third pairs of legs, and whitish in color with a smooth cuticle. A few long, fine hairs are present on the body and legs. It has long, beak-like mouth parts for piercing the trachea.

The entire life cycle of this mite is spent within the respiratory (tracheal) system of the honey bee, except for brief migratory periods. Within 24 hours after worker bees emerge from their cells as new adults, female mites collect within their tracheae, where the microscopic mite feeds and reproduces. Each female mite lays five to seven eggs, which require 3 to 4 days to hatch. Male and female mites develop from egg to adult in approximately 11 to 15 days. Eggs hatch into six-legged larvae, then molt to a non-feeding or pharate nymph stage, and then finally molt to the adult stage. All stages of the mite—eggs, larvae, pharate adults, and adults—may be found in the tracheae of older bees.

Tracheal mites are spread within colonies as a result of bee-to-bee contact. Only adult female mites emerge from the tracheae through spiracles (openings to the outside) and attach themselves to the tip of the bee's hair. As bees come in contact with one another, the mites attach themselves to the body hairs of a passing bee and enter the tracheae through the thoracic spiracles. Bees less than 4 days old are the most susceptible. Bees drifting between colonies can spread tracheal mites to other colonies.

Positive identification of tracheal mites can be done only by dissection and microscopic examination of honey bee thoracic tracheae. The tracheae of healthy, uninfested bees are clear and colorless or pale amber in color. In a slight infestation, one or both tracheal tubes contain a few adult mites and eggs, which may be detected near the spiracular openings. At this stage, the infested tracheae may appear clear, cloudy, or slightly discolored.

Infested tracheae undergo progressive deterioration and show patchy discoloration. The tracheae of severely infested bees have brown blotches with brown scabs or crust-like lesions or may appear completely black and are obstructed by numerous mites in different stages of development. Feeding by the mites damages the walls of the tracheae. The bee's flight muscles (in the thorax) may also become atrophied in severe infestations. The lives of adult bees are shortened and their flight efficiency and perhaps thermoregulatory ability are also affected.

As mite populations increase, colony populations dwindle, which ultimately can lead to the death of the colony. Many infested colonies die in late winter or early spring. Colonies killed by tracheal mites during the winter typically have honey stores remaining and a small cluster of dead bees. However, severely infested colonies also can die during the spring, summer, or fall. When a colony is near death, large numbers of bees may be seen crawling out of the hive unable to fly. These bees may display abnormally positioned wings that look disjointed ("K" wings) and may be trembling—symptoms that can result from diseases associated with the tracheal mites.

Control of these mites has been mainly through the application of menthol and grease patties. However, several strains of bees bred for resistance to tracheal mites are now available.

For detailed information on approved chemicals and their use for treating tracheal mite, see the appendix or visit the MAAREC Web site: [maarec.cas.psu.edu](http://maarec.cas.psu.edu). If you do not have Internet access, contact your local cooperative extension office.

## Pests

### SMALL HIVE BEETLE (*Aethina tumida*)

Our newest bee pest was first identified in Florida in the spring of 1998. Before its discovery in the United States, the beetle was known to exist only in tropical or subtropical areas of Africa. How it found its way to North America is not certain. Since adults will feed on fruit and are especially fond of cantaloupe, the beetles may have been accidentally introduced into this country via a shipment of fruit originating from Africa.

While the small hive beetle is not considered a serious pest in South Africa, some Florida beekeepers experiencing heavy infestations have seen the quick collapse of strong colonies. The beetle is commonly found in apiaries in Florida, Georgia, and the Carolinas. They were also found in supers of honey sent north from Florida and in packages distributed in several states. Areas where it has successfully established itself appear to be mainly restricted to regions along the East Coast of the United States where sandy soil conditions allow the beetle to successfully complete its life cycle.

The adult beetle is small (about  $\frac{1}{3}$  the size of a bee), reddish brown or black in color, and covered with fine hair (Figure 50). The larvae are small, cream colored, and similar in appearance to young wax moth larvae. You can differentiate the beetle



**Figure 50.** Adult hive beetles in a weak colony. (Courtesy Maryann Frazier)



larvae from wax moth larvae by examining their legs. Beetle larvae have three sets of legs just behind the head. Wax moth larvae, like all moth and butterfly larvae, have three sets of legs behind the head, but in addition have a series of paired prolegs that run the length of the body. Prolegs are absent in beetle larvae.

Adult females lay their large egg masses on or near beeswax combs. The eggs hatch in a few days, producing a great number of small larvae. The larvae consume pollen and wax but also will eat honey bee eggs and larvae. They complete their larval stage in 10 to 16 days and then drop to the ground where they pupate in the soil. Adults emerge from the soil in approximately 3–4 weeks. The females are capable of laying eggs approximately one week after emerging from the soil. They are good flyers and easily disperse to new colonies where they deposit eggs to begin a new generation. Close observation of beetle-infested colonies in Georgia has shown that the beetles completely shut down reproduction during winter.

While the beetle is considered a minor pest in South Africa, the U.S. experience to date would suggest that it has the potential to be a more serious pest, at least in some areas of the country.

Some beekeepers have reported that beetles are able to take over even strong colonies. However, in the majority of cases it is the weak and/or diseased colonies that are infested and succumb to this pest. Also vulnerable to attack are full honey supers stored in the honey house or on hives above bee escapes for long periods of time. Once beetles get

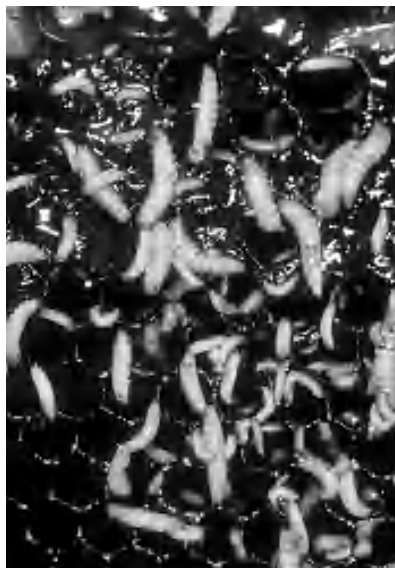

**Figure 51. Masses of hive beetle larvae. (Courtesy Maryann Frazier)**

a foothold, even a few adults can produce masses of larvae (Figure 51). In addition to consuming the resources of the colony, the adult beetles defecate in the honey, which causes it to ferment and run out of the combs. When small hive beetle infestations become heavy, queens will stop laying eggs and the colony will dwindle or abscond.

All spring and subsequent hive inspections should be done with an eye open for this pest. When opening a hive containing beetles, they can be seen running across the combs to find hiding places. Adults may also be detected under top covers or on bottom boards. If an infestation is heavy, both adults and masses of larvae may be seen on the combs and bottom board. These larvae do not produce silken tunnels, webbing, or cocoons in the hive (as wax moth larvae do).

Varroa mite sticky boards are ineffective for use in detecting adult beetles. The beetles move easily across the sticky material even if the boards are coated with a stickier material such as Tanglefoot®. However, corrugated cardboard with the paper removed from one side, placed on the bottom board at the rear of the hive, has been successfully used in detecting adult beetles. The beetles appear to seek shelter in the corrugations.

Fermented honey exuding from full supers in storage, waiting to be extracted, or on active colonies, is a sign that hive beetles may be present. A “decaying orange” odor may be given off by the fermented honey.

If you find evidence of, or are concerned about the possibility of, a hive beetle infestation, you are urged to immediately contact your state apiary inspector (Department of Agriculture; see appendix). To reduce the threat of this pest in your apiary(ies), you should take the following precautions:

- maintain only strong, healthy colonies
- keep apiaries clean of all equipment not in use
- extract honey as soon as it is removed from colonies
- destroy beetles as soon as they are detected

Chemical pesticides approved for treating hive infestations and larvae pupating in the ground are available. For detailed information on approved chemicals and their use for hive beetles, see the appendix or visit the MAAREC Web site: [maarec.cas.psu.edu](http://maarec.cas.psu.edu). If you do not have Internet access, contact your local cooperative extension office.

## ANTS

Ants are not usually serious pests in honey bee colonies. Occasionally, however, certain species may enter colonies to search for food or establish nesting sites. The presence of ants may indicate a weak colony or a colony with problems. Ants are typically found between the inner and outer covers of the hive and in pollen traps. Even though ants seldom disturb the bees, they can become a nuisance to the beekeeper. Once they are established in a colony, they are difficult to control.

To reduce ant problems maintain strong colonies and keep bottom boards raised off the ground. Remove brush, rotten wood, grass, and weeds from around the colonies. A fuel oil barrier applied to the soil under the colonies may be helpful. Single colonies can be placed on stands with oil or sticky barriers. When ants are a persistent problem, beekeepers may have to use approved insecticides for control. Use extreme caution when applying insecticides in the apiary. Insecticides that are effective in controlling ants are also highly toxic to bees. Apply insecticides when the bees are inactive.

## BEE LICE

*Braula coeca*, or bee louse, is an external parasite of adult bees. The adult lice are small (slightly smaller than the head of a straight pin), reddish brown, wingless flies. They first appeared in the United States as “hitchhikers” on the bodies of imported queens. While several adult flies may live on a queen, usually only one lives on a worker. Bee lice seem to prefer nurse bees; only rarely do they live on drones. *Braula* move rapidly over the body, settling on the dorsal surface at the junction of the bee’s thorax and abdomen. They remain there until a hunger response causes them to crawl up to the bee’s head near its mouthparts. This movement seems to irritate the bee, causing it to regurgitate a drop of nectar. *Braula* then inserts its mouthparts into those of its host and takes its food. Bees actively try to remove the lice.

The louse lays its eggs on the cappings of honey storage cells during May through July. After oviposition, the adults die. Upon hatching, the young larvae burrow into the cappings. As the larvae grow, their tunnels lengthen and broaden; at this stage the infestation is easiest to detect. The larva pupates inside the tunnel after making a line of weakness in

the wax to aid in its emergence as an adult. Soon after emergence—about 21 days later—the young adult crawls upon a bee. The diet of the larva appears to be wax and perhaps pollen grains incorporated into the wax by worker bees. Bee lice overwinter as adults and do not appear on queens until June.

*Braula*’s damage to a colony of honey bees is limited. The amount of food taken by the larvae and adults is negligible. However, the appearance of comb honey can be damaged by tunneling larvae. Honey production by strong colonies infested with bee lice appears to be little affected. Little work has been done on control of *Braula*, and the measures that are suggested are antiquated. Since the introduction of parasitic mites and the treatment of these mites with chemical pesticide, *Braula* is now quite rare in honey bee colonies.

## WAX MOTHS

Larvae of the greater wax moth, *Galleria mellonella*, can cause considerable damage to beeswax combs left unattended by bees. Frames in weak or dead colonies and those in storage are subject to attack. Wax moths pose a continuous threat except when temperatures drop below 40°F (4°C). Strong colonies keep these grayish-white larvae under control.

Adult female moths fly at night and deposit masses of eggs on unprotected beeswax combs and in the cracks between hive bodies. After a few days, these larvae hatch, crawl onto the comb, and begin their feeding activity. They damage or destroy the combs by boring through the cells as they feed on cocoons, cast skins, and pollen. As they chew through the wax, they spin silken galleries for protection (Figure 52). Beeswax combs are often reduced to a mass of webs and debris. Wax moth larvae seldom attack new frames or foundation.

Larval developmental time depends on temperature. The larval stage may last from 28 days to 5 months, depending on nutrition and environmental conditions. During this period, larvae may vary from  $\frac{1}{25}$  inch to 1 inch in length.

When fully grown, the larva spins a rough silken cocoon, which is usually attached to the frame or inside of the hive. Frequently, the larva cements the cocoon inside a boat-shaped cavity chewed in the wood. Chewed frames are weakened and easily broken. Within the cocoon, the larva changes to the

pupa; it overwinters in the pupal stage. Under warm conditions, adults may emerge at almost any time of year.

At the present time, two approaches can be used to protect combs: paradichlorobenzene and cold temperatures. When placing combs in storage, be sure to kill any existing stages of wax moth and guard against later infestations. Freezing weather kills all stages of wax moth, so some beekeepers keep supers on the bees until after a killing frost. Supers are best stored in a dry unheated building.

If supers must be stored during warm weather or in a warm room or basement, they may be protected by placing paradichlorobenzene (PDB) crystals on a small piece of paper on every fifth super in the stack, which should then be covered. The treatment must be continued at regular intervals all winter. PDB kills adult and immature wax moths, but not eggs. The continuous presence of crystals within the stack not only repels moths and prohibits egg laying but also kills any young larvae that hatch after the frames are placed in storage. Comb should be inspected regularly for signs of infestation, especially if temperatures rise above 60°F (15°C) and permit wax moth activity. Supers should be aired before using them in the spring. PDB can be used to protect all combs in storage except those containing honey intended for human consumption. The odor of PDB is readily absorbed by honey, and, though the bees do not object to this odor, such honey is unfit for human consumption.

**CAUTION:** *Mothballs or moth crystals of naphthalene must not be used to control wax moths.*



**Figure 52.** Comb damaged by wax moth attack. Note webbing and tunneling by feeding larvae. (Courtesy Maryann Frazier)

The larvae of the wax moth do considerable damage to comb honey. The eggs are probably laid on the comb or section boxes before the comb honey supers are removed from the hives, but the damage does not become evident until sometime after the honey has been placed in storage. The only approved method for preventing wax moth damage to comb honey is freezing. The USDA recommends a temperature of 0°F (-18°C) for 24 hours to kill wax moths. Small amounts of comb honey can be stored in the freezer. This not only prevents wax moth damage but also retards crystallization.

### MICE

Mice are serious pests of stored combs and active honey bee colonies during the fall and winter months. These rodents chew combs and frames to make room for building their nests (Figure 53). Mouse urine on combs and frames makes bees reluctant to clean out these nests in the spring.

Adult mice move into bee colonies in the fall and usually nest in the corners of the lower hive body away from the winter cluster. Colonies in apiaries located in fields or at the edges of woodlots are especially vulnerable. Mice can successfully build a nest even in a strong colony. They move in and out of the colony while the bees are inactive, and their nests furnish additional protection. Their activity may disturb the bees, but the greatest damage is from the nest building of the mice.

Early in the fall, hive entrances should be reduced with entrance cleats or hardware cloth (3-mesh to the inch) to keep out mice (Figure 30,



**Figure 53.** Colony infested with mice in winter. (Courtesy Dewey Caron)

page 31, lower insert). Chase away any mice found inside a colony, then remove the nest and restrict reentry. If comb chewing is extensive, replace the frames. When bees repair damaged combs, they replace worker-sized cells with drone comb.

Combs in storage should be protected from mice by covering the top and bottom of each pile of supers with a queen excluder, wire screen, or outer telescoping lid.

### SKUNKS, OPOSSUMS, AND RACCOONS

In some localities, skunks, opossums, or raccoons can be a serious nuisance and even a threat to successful beekeeping. Being insectivorous (insect-eating), these predators will raid the bee yards nightly, consuming large numbers of bees and hampering the development of strong colonies. While such attacks are most common in the spring or fall, they also can occur throughout the summer. To capture their prey, skunks scratch at the hive entrance; when the workers come out to investigate the disturbance, they are knocked down and eaten. Skunks chew on the bees until all the juices are consumed, then spit out the remains. A successful skunk will repeat the process several times and may feed at the hive entrance for an hour or more. In addition to rapidly depleting the adult bee population, all of these predators make a colony very defensive since they usually return night after night. Besides the front of the hive being scratched up and muddy, the grass in front of the hive will be packed down or torn up and small piles of chewed up or defecated bee parts will be visible. Strong colonies sometimes put up a good fight, but weaker colonies usually fall victim. Therefore, maintaining strong colonies is a partial deterrent to predator attack. These animals also may be discouraged by screens or queen excluders attached to the front of the hive and covering the entrance or by elevating the hive (Figure 54). These devices hamper scratching at the front entrance, and if a predator climbs up the screen over the entrance, its belly becomes vulnerable to stings. Fencing the bee yard or placing the colonies on stands would be an effective technique, but the cost may make it prohibitive. Moving your bees to a new location is another approach considered impractical in most cases.

Currently, no chemical repellents or toxicants are labeled for controlling predators. Since all of these are classed as fur-bearing animals, they are protected except during the annual trapping season

(late autumn). However, the landowner has the right to kill wild animals engaged in the material destruction of cultivated crops, fruit trees, vegetables, livestock, poultry, or beehives.

### BEARS

In the mountainous and heavily wooded areas of the Mid-Atlantic region, bears are an increasingly serious threat to beekeeping operations. Bears can do a great deal of damage to hives and equipment in a short period of time. They normally visit apiaries at night, smashing hives and scattering frames and equipment around the apiary to get to the brood and honey. Once bears locate an apiary, they return again and again. Damage to bee colonies is more likely to occur in early spring when young adult bears come out of hibernation and in the fall before young males enter hibernation dens.

Conflicts between bees and bears are not new, but in recent years the problem has escalated. Black bears once ranged over the Mid-Atlantic region. Increased urbanization, cultivated acreage, and the trend toward monocultural agriculture have rapidly reduced both bee pasture and suitable bear habitat. Today, bears are basically limited to wilderness areas but increasingly are appearing in subdivisions and outlying areas. The extensive use of herbicides and insecticides has reduced bee pasture and forced beekeepers to move their outyards into remote areas to avoid pesticide kills, and some of the safest/best bee forage is located in areas of high bear density. Pennsylvania, the most heavily bear populated state in our region, may have as many as 15,000 bears, and in some areas the population exceeds one bear per square mile.



**Figure 54. Elevation of hives to reduce small animal and ant/termite damage. (Courtesy Dewey Caron)**

Solutions to the complex bee/bear conflict are highly political, expensive, and have not been totally effective. Concessions need to be made by all sides. Beekeepers, game commission personnel, sports enthusiasts, and environmentalists must work together to help save both bee and bear habitat and work to develop management schemes that will be favorable for both animals.

The beekeeper can take several precautions to reduce the chances of bear damage. Typically, bears move through their home ranges with preferred travel lanes or bear crossings that often follow along certain ridges, ravines, streambeds, or the forest edge. While these are not necessarily beaten paths, they may be. Beekeepers can help avoid damage from bears by careful selection of the apiary site. Placing colonies on or near bear crossings, fall berry foraging sites, or garbage dumps that bears frequent is more likely to result in hive damage. Spreading litter around an apiary site or leaving bits of burr/brace comb and pieces of drone brood removed from frames on the ground around the hive may invite trouble. Research has shown that the farther bee yards are located from the forest edge and ravines, the less chance there is of bear visitation.

Getting to know game commission personnel in your area before bear damage occurs can be invaluable. They can provide estimates on the size of the bear population for different areas and help identify known bear crossings. Whenever possible, game commission personnel try to get the bear to move on or trap nuisance bears and move them to areas where damage is less likely to occur. They use baited culvert traps mounted on a small trailer or special foot snares to capture problem bears. Such programs are expensive, and relocated bears may become someone else's problem. Repeat offenders are sometimes killed.

Nonlethal controls that can be used to deter bears include:

- Loud noises (e.g., horns, clapping, shouting, pyrotechnic salutes), bright lights, or other harassment techniques
- Bear hounds or guard dogs to ward off bears
- Habitat manipulation (e.g., removal of protective cover) to make a site unsuitable for or unattractive to bears

- Aversive conditioning using a chemical such as lithium chloride to "teach" bears to avoid certain foods (results have been disappointing)
- Bear fences

An apiary can be protected from bears by erecting an electric fence, but this must be done before bears begin to damage colonies. Bear fences must be dependable, relatively cheap to construct, and capable of operating in the wilderness (Figure 55). An electric fence must be well grounded, sufficiently charged at all time, and maintained on a regular basis (e.g., cutting or applying herbicide to vegetation growing under the fence and ground mat, repairing snow damage, recharging the battery, maintaining the integrity of the fence, and checking wire voltage with a voltmeter). Permanent or temporary bear fences can be made from multiple strands of electric wire or woven wire attached to wood, steel, or fiberglass posts. Key features of fence design are strand spacing, energizer type, and grounding effectiveness. Wire strands on a permanent fence should be no more than 8 inches apart and not more than 12 inches apart on a temporary fence. The bottom wire should be within 8 inches of the ground; the top wire need not be higher than 3½ feet.

To be effective, the fence power supply must be dependable and recharged when necessary. Batteries can be housed in an empty box beneath an occupied hive or in an empty hive body. Be careful not to position colonies too close to the fence itself—3 feet or more is best. Include a wire mat (earthing a 3-foot chicken wire skirt) around the outside perimeter to prevent bears from digging beneath a fence. Having some kind of bait (e.g., suet, bacon strips, or pork



**Figure 55.** Apiary in remote location protected by a bear fence. (Courtesy Dewey Caron)

rind) attached to the wires is important. The bait gives the bear a proper introduction to the electricity when it touches the tempting morsels with its moist tongue or nose. Without the bait, the bear is likely to crash right through the wire as impervious to the electricity as it is to bee stings. During warm weather, bacon or pork rind does not last long, so the beekeeper must continue to replace old with new.

Fences are totally ineffective if not installed and managed properly. They also are of little help if a bear has already established a pattern of visiting an apiary site. Avoid sites with overhanging trees because limbs falling across the wires may render the fence inoperable. It is also quite common for bears to climb trees and then drop down inside the fence. To ensure a continued successful operation, you must control grass and weeds along the fence so that they will not contact the charged wires and short them out. If wires are too far apart and a bear can get its head inside the fence, it will tend to lunge forward when subsequently shocked, thus destroying your barrier.

The MAAREC Web site ([maarec.cas.psu.edu](http://maarec.cas.psu.edu)) provides details on fences and additional sources of useful bear fence information and features an illustration of a bear fence design.

Under Pennsylvania state law, bears may be killed when caught in the act of destroying property. When a bear is killed, it must be reported to the game protector within 12 hours. Failure to do so may result in a stiff fine. Maryland prohibits killing bears for any reason, but, when notified, will work with a beekeeper to try to alleviate the problem. In West Virginia, the DNR (Department of Natural Resources) will issue permits for destruction of problem bears after two attacks by the same bear in the same location. In New Jersey, homeowners (and beekeepers) can shoot a bear if it is caught in the act of damaging bees. Wildlife Services must be notified within the hour. The New Jersey Department of Environmental Protection will trap and kill offending bears or they will issue kill permits for depredating bears. Delaware has no bear population.

Beekeepers who suffer damage from bears may be eligible for compensation from the Pennsylvania Game Commission or the Maryland and West Virginia Departments of Natural Resources. In Pennsylvania, to be eligible for remuneration the beekeeper must be a resident of the Commonwealth and report the damage within 7 days. The hives must be

on land open to public hunting when damage occurred and the hives must be within 300 yards of the residence of the owner or the owner's agent. In Maryland, DNR reimburses individuals that have suffered loss of property or crops due to bears. Damage must be valued at more than \$200 with a maximum of \$3,000 per year. Reimbursement money comes from a "bear stamp," and if claims exceed funds available, each individual gets a prorated share in reimbursement. Both the Maryland DNR and PA Game Commission will provide bear fencing equipment at no charge to beekeepers that have suffered loss to bee colonies from bears. West Virginia DNR pays bear damage claims from a bear stamp fund with the requirement that they be notified within 3 days of discovery of damage, obtain damage estimates from three individuals, and receive a payment request submission within 30 days.

#### MISCELLANEOUS PESTS

A host of other organisms may feed on bees or live within or in close proximity to a bee hive. Snakes, rodents, and spiders enjoy the cool, safe environment beneath bee colonies. Spiders enjoy them for web building, while flower ambush crab spiders capture and eat field bees or, as in the case of the jumping spider, live within the hive covers. Predacious flies, bugs, dragonflies, praying mantis, and a host of similar insects might capture and feed on field bees. Several insectivorous birds, like martins and mocking birds, do likewise. Although perilous for individual bees, such occasional pests are seldom numerous enough to cause serious damage or require beekeeper intervention.

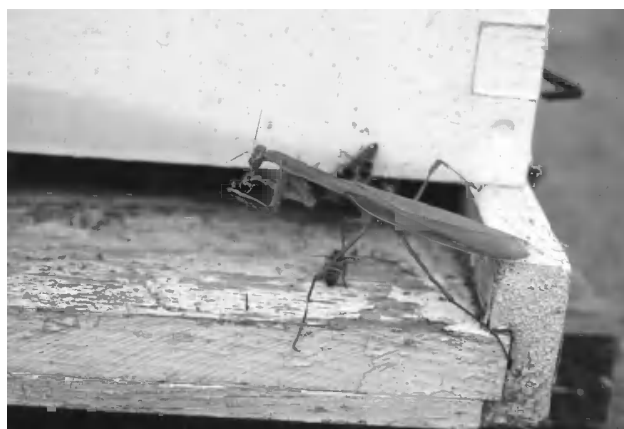

**Preying mantids are a minor bee pest, even when they visit the alighting board. (Courtesy Dewey Caron)**

## Protecting Honey Bees from Pesticides

Pesticide poisoning of honey bees is a serious problem for beekeepers, especially near areas of intensive agricultural crop production. Pesticides work in two ways to reduce bee populations. First, many pesticides necessary in crop production are highly toxic to honey bees. Second, the use of herbicides reduces the acreages of attractive plants for the bees to forage on. Direct pesticide damage to colonies takes many forms. Bees may be poisoned when they feed on nectar or pollen contaminated with certain pesticides (Figure 56). Bees may also be poisoned when they fly through a cloud of pesticide dust or spray or walk on treated parts of a plant. Bees may be overcome by the fumigation action of certain pesticides, either in the field or in the hive if the material has drifted there. Colonies may be completely destroyed by a pesticide, but more commonly only field bees are killed. Loss of field bees can be serious because it greatly hinders the ability of the colonies to build up strong populations, which is the beekeeper's most vital key to successful honey production or pollination. If the field force is destroyed by pesticides, the whole colony will be weakened and may remain weak for some time; the queen may reduce egg laying or be killed by the workers; and the colony may fail to survive the winter, produce a crop of honey, or be useful for crop pollination.

Not all pesticides are equally hazardous to bees, and beekeepers must acquaint themselves with the pesticides commonly used in their areas. When practicable, place colonies away from fields routinely treated with pesticides. Let farmers in your area know where your bees are located. Post your name, address, and phone number in a conspicuous place in your apiary. Be prepared to confine or remove your bees if you are notified that a hazardous pesticide will be applied.

You may cover colonies with plastic sheeting that will confine the bees and exclude pesticide spray, dust, or fumes. Since heat builds up rapidly under plastic exposed to the sun, confinement should be limited to a few hours after dawn. This may be long enough to protect the bees from some pesticides that do not have a prolonged residual effect.

Alternatively, you may cover hives with wet burlap for a day or more, even during the hottest weather, and the bees will not suffer from lack of air and water. Cover the hives at night when all the bees are inside. During the day, soak the burlap with water at least once every hour. Covering the colonies is usually not practical where repeated applications are made. Burlap probably would not give complete protection to colonies located in a field treated with a pesticide that has fumigating action.

Bees use water in their food and for cooling the hive. Colonies under confinement soon become stressed if they lack water. Water shortage causes symptoms similar to spray poisoning. If wet burlap is used to cover colonies, it provides water for the bees and helps cool the colony.

The safest way to protect colonies in danger of exposure to pesticides is to move them to a new site. Moving is a lot of work but it is undoubtedly the safest alternative for colonies in danger of pesticide poisoning.



**Figure 56. Honey bee foraging on raspberry flower.**  
(Courtesy Maryann Frazier)

# Honey Production and Processing

## Forms of Honey

Honey is marketed in five basic forms: section comb, cut-comb, chunk, finely crystallized or creamed, and extracted (liquid) honey (Figure 57). Equipment needs and management vary with the type of honey you plan to produce.

Most beekeepers produce extracted honey. More surplus honey can be obtained from colonies managed for extracted honey than from those managed for comb honey. Combs used for extracted honey production require some type of reinforcement such as wires, threads, or sheets of plastic. These materials, however, would not be palatable to the consumer of chunk, section, or cut-comb honey. The production of extracted honey also requires special equipment for uncapping combs and removing honey from cells. Both cut-comb and chunk honey production require similar management, and most of the equipment can be used interchangeably. Cut-comb honey, the least expensive to produce, is ideal for the beginner. Section comb honey requires specialized equipment, intense management, and an abundant nectar flow for good returns and is not normally recommended for beginners.



**Figure 57. Extracted and chunk honey. (Courtesy National Honey Board)**

## SECTION COMB HONEY

Section comb honey is produced and sold in the comb in either small wooden ( $4\frac{1}{4} \times 4\frac{1}{4}$  inches or  $4 \times 5$  inches) or round plastic sections (Figure 58). Comb honey producers practice two basic systems of spring management, depending on the size of brood chambers used. These two systems, of course, have a number of management options.

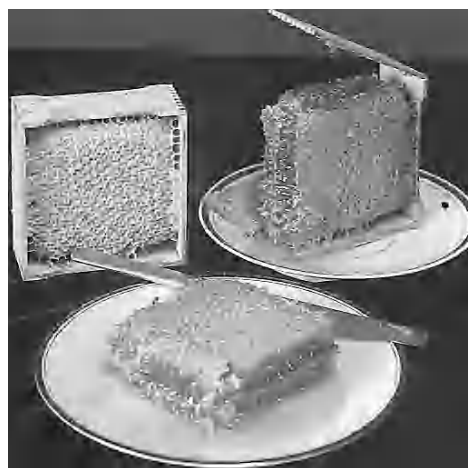

**Figure 58. Traditional section honey with a comb ready for the table in front (Courtesy of U.S. Department of Agriculture)**

The simplest method of producing comb honey is to winter the bees in a  $1\frac{1}{2}$ -story brood chamber. A second shallow box may be added about the time maples or fruit trees are in bloom if the spring flow is heavy. When the main nectar flow has started, place the queen in the full-depth hive body and insert a queen excluder below the shallow super. When the bees have stored honey in all but the two outer frames of the shallow super, the colony is ready for a section super. Place the section super below the queen excluder. Queens seldom lay eggs in the sections since the space is divided into small compartments. An excluder placed below a section super sometimes retards the work of the bees in the sections but it does not seem to retard work in supers, especially if the bees are already working in them. The honey and brood in the shallow super encourage the bees to work in the section super quickly since they are already accustomed to going into the super above. Add an additional section super as soon as the bees have begun to work in the outside rows of sections in the last super added.



Place empty supers under the excluder and on top of the other section supers. If colonies are strong and the nectar flow is good, a colony may fill as many as four or five section supers. Placing empty section supers above those partially filled supers keeps the workers more organized. Workers do a more complete job of filling and sealing the sections as they work upward into the empty super. Alternately, you may raise the first super when it is half sealed and place a partially drawn super underneath. This manipulation of supers reduces the risk of "travel stain" on the section cappings from the brood chamber below. When supers are added too quickly, they may contain partially filled sections with little or no market value. Skillful production of comb honey takes practice and good nectar flows.

The second management system for comb honey production involves allowing a colony to fully expand into two full-depth brood chambers.

Beekeepers with considerable experience can successfully use this approach. The double brood chamber provides the queen with an abundance of space for egg laying and the colony with plenty of space for honey. Additional space for brood rearing is generally not needed. In late April, the brood chambers are normally reversed and the colony fed a light sugar syrup to stimulate colony expansion as described in the section on spring management.

Unless there is a very heavy nectar flow, bees will not fill section combs successfully when the section supers are placed above two hive bodies; they are more likely to fill the two brood chambers and then swarm. For this reason, one brood chamber is normally removed and the bees crowded when the main honey flow begins. You can determine the beginning of the flow by the presence of new white wax on the combs and on the top bars of the brood frames. New nectar that falls out easily when shaken will also be in the brood combs.

Place the queen in the lower hive body with five frames of sealed brood and five empty combs when you reduce two-story colonies to a single story. Place the remaining combs in an empty hive body after shaking about two-thirds of the bees from them in front of the lower hive body. Give the colony one or two section supers, depending on its strength. You may set the second hive body on a weak colony or use it to develop a new colony.

For best results, bait section supers with a few partly drawn sections saved from the previous season. When using bait sections, place four of them in the center row of sections. Bait sections used in

the initial super are often poor in quality when filled and should not go to market.

When bees are well started in the outermost sections of the super and there is reason to expect the nectar flow to continue, add another super. Do not give room before the bees need it. Add more supers judiciously toward the end of the nectar flow; otherwise, many sections will be started that will not be finished in salable condition. Place the empty super above the partially filled one as described previously. Bees will then finish the sections as they move up.

When a section super is completely sealed from top to bottom, except for the two outside rows, remove it and place it above a bee escape. Do not remove sections with smoke because the bees will chew tiny holes through the cappings during smoking, producing leaky sections. In addition, the honey may absorb the flavor of the smoke and become distasteful.

Use unfinished sections from the outside rows as bait sections in the next super, when they are given to the bees. When the flow is about over, remove the sections and store them in a freezer for the next season. To determine when a section super is full, look at the bottoms of the sections since these are the last parts to be sealed. If nectar is coming in fast, adding a super every few days is advisable. Adding supers at the proper time requires good judgment and knowledge of local conditions.

Just as important as adding supers at the opportune time is their removal in a timely fashion. If a finished super is left on the hive too long after the combs are sealed, cappings will become dirty or "travel stained." Five to eight days are required to ripen nectar; therefore, all honey should be ripe 12 days after the flow stops.

Examine the brood areas of all colonies producing comb honey for queen cells every 8 to 10 days for the duration of the swarming season. This is especially important when bees from two brood boxes have been reduced to a single brood box. Destroy all queen cells; if any cells are missed, the colony may swarm.

Section boxes for producing comb honey should be folded, filled with foundation, and placed in supers only shortly before use. If made too far in advance, they may be less attractive to the bees or can warp. The boxes will then be ready for immediate use during the nectar flow. When folding the wooden section boxes, moisten all grooves with a damp sponge, rag, or fine spray of water or steam to prevent breakage at the corners. Make sure the

sheets of thin surplus foundations are the same length and depth as the four sections and they are positioned in the middle of the boxes. Split wooden sections and plastic sections assemble faster than solid section boxes.

Place four folded sections, with the split side up, in the section holder. Spread the tops of all four sections. Drop the sheet of foundation into the space left between the two halves of the four sections and push the sections together to hold the foundation tight. Devices for putting foundation in split sections are available from bee supply dealers. Comb honey is more attractive and more economically produced when you use full sheets of foundation.

If you prefer solid sections, cut the foundation about  $\frac{1}{8}$  inch smaller each way than the inside of the sections. Prepare four or eight blocks, each block  $\frac{1}{8}$  inch smaller than the inside of the section. Blocks should be  $\frac{1}{8}$  inch thinner than  $\frac{1}{2}$  the depth of the section (e.g., blocks for  $1\frac{7}{8}$ -inch sections should be  $\frac{7}{8}$  inch thick). Place the sections over the blocks and lay one sheet of foundation on each block. Then slide a hot blade between the section and the foundation. Push the foundation against the hot blade as you withdraw the blade. The melted edge of the foundation will slide against the section and adhere as it cools. The blade may be a wide scraping knife or similar tool, but it should be the same width as the foundation. Insert the sections into a section holder. The foundation should then hang free of both sides and very near the center of the section. It should come within about  $\frac{1}{8}$  to  $\frac{1}{4}$  inch of the bottom. The foundation should not rest on the bottom because it stretches a little when placed in the hive. If it reaches the bottom, it may buckle and distort the resulting comb. Do not place the sections in supers until they are needed. One or two poorly fastened sheets of foundation falling down in a super after it has been stored or given to the bees may cause considerable loss and inconvenience after the super has been filled by the bees.

Paint tops of split or solid sections with melted paraffin or cover them with masking tape so the bees cannot stain the sections. Melt the wax in a double boiler with water in the bottom. Never place a pan of paraffin wax on a burner because the wax may catch fire or get too hot. If the wax is too hot, it darkens the sections.

Remove finished supers carefully and without smoke to avoid damaging the cappings. Remove

wedges or materials used to keep sections together in the super. Place the super on a 1-inch-thick board or block of wood just large enough to slip inside the super. Press down on the hive body to force the section holders and separators out of the super body so they can be readily separated and the sections scraped and cleaned.

Carefully scrape sections free of propolis and remove the masking tape. This operation requires much care to avoid damaging marketable sections. After cleaning, weighing, and grading sections, wrap them in cellophane bags or cardboard cartons with a cellophane front. The cardboard carton is favored because it better protects the delicate section.

Traditional wooden sections are difficult to produce in quantity or quality. Some beekeepers who want to produce section honey have opted for Ross Rounds Section Comb (sometimes Round Section Comb). You must purchase a special super that has round plastic rings that hold 12 ounces of honey when filled. The section super will hold 36 of these round sections (versus 24 in the wooden section super) and there is no scraping, and assembly of foundation is relatively easy. Attractive plastic covers and a specialty label offer sales appeal. The product sells for about the same price as the square sections, but due to smaller size more are produced and they are of better quality; there does not seem to be consumer reluctance to purchase the plastic sections when available.

A half-comb cassette for producing comb honey is also available. It is basically one side of the normally two-sided comb held in plastic boxes in specialty supers. Packaging is attractive and there is virtually no assembly needed. A super produces 40 units when completely filled. Market acceptance has not been tested, but it is expected to sell well as a specialty product.

Comb honey should not be produced in the fall from the nectar of wild flowers since this honey crystallizes more quickly than most summer honeys. Fall honey should be produced in supers used for extracted honey.

### **CUT-COMB HONEY**

Cut-comb honey is much easier to produce than section comb honey since you do not have to crowd the bees to force them to work in the section supers. Fill shallow supers with frames of thin foundation, fastening the foundation at the top with the wedge

of the “wedge-type” top bar or with a bead of wax to a grooved top bar. Special thin top bar frames are sold just for cut-comb honey, but they are not required. Place the supers on the hive over a queen excluder to prevent brood production in them.

When a super is sealed and removed from the bees, cut the combs out of the frame, divide them into pieces of the desired size, and let them drain overnight on a wire rack over a drain pan in a warm room.

### **CHUNK HONEY**

Chunk honey is normally produced in shallow frame supers with thin surplus foundation in the frames, just as you would produce cut-comb honey. A wooden wedge or bead of melted beeswax holds the foundation at the top of the frames.

Bees are managed in much the same way as required for comb honey, except that supers are added above the queen excluder. Allow the queen to expand her brood in a shallow or medium hive body above the full-depth hive body in early spring or use two standard deep hive bodies. When the upper hive body is about  $\frac{3}{4}$  full of honey and brood, you must move the queen down to the lower standard hive body and confine her there with a queen excluder. After 4 or 5 days, place an empty super with frames and foundation below the upper full one but above the queen excluder so that the queen cannot lay eggs in it. Add more supers as needed. Place an empty super on top of the stack until the bottom one is  $\frac{3}{4}$  full, then reverse them. Continue adding supers in this way. Remove supers using a bee escape and control swarming in the same way you would control colonies managed for comb honey.

After removing fully capped frames, cut the comb into chunks large enough to fill a wide-mouth jar. Before putting them in the jars, place the chunks on a screen and let them drain over a drain pan in a warm room for several hours. Fill empty spaces in the jar around the comb with liquid honey that has been heated to 140°F (60°C) before pouring it over the comb in the jar. Heating the liquid honey delays crystallization for several weeks. Types of honey that crystallize quickly, such as alfalfa or wild aster, are not well suited to chunk honey production because they crystallize on the grocer’s shelves. Label the product for sale as chunk honey.

### **CREAMED HONEY**

Creamed or finely crystallized honey is easy to prepare for home use and/or for sale. The crystallization or granulation of honey is related to honey composition and storage conditions. Some honeys never crystallize; others do so within a few days of extraction or even while still in the comb. When honey is allowed to granulate naturally, the sugar crystals are coarse and have a gritty texture that reduces the commercial value of the product. However, speeding up the granulation process and seeding the liquid honey with finely crystallized honey, will produce creamed honey with small crystals of uniform size. If done under proper conditions, the creamed honey spreads like butter at room temperature and retains a smooth texture.

Since the granulation of honey always increases the possibility of fermentation, you must heat the honey to 150°F (66°C) to kill the yeasts responsible for fermentation. Filter the totally liquefied honey through two or three thicknesses of fine cheesecloth or nylon to remove all wax particles and other bits of debris upon which crystals could form, then rapidly cool the honey to about 80°F (27°C). Slightly warm about 10 percent finely crystallized honey and add this to the cooled honey. Adding the finely crystallized honey is known as seeding because it causes other crystals to develop. Stir the seed carefully into the cooled honey so that the lumps of seed are all broken without incorporating air bubbles. Forcing the seed through a screen or using a hand-operated food or meat grinder will produce the necessary soft creamy mass. Allow the seeded mixture to settle for an hour or two, skim off the foam if necessary, and pour into desired containers. Again, be careful not to incorporate air bubbles. Keep the containers at a temperature between 54°F (12°C) and 60°F (15°C)—57°F (14°C) is ideal—and the honey will be smoothly crystallized within a week or so. If the creamed honey is too hard to spread easily, keep it at room temperature until it softens. This technique will allow you to prepare small quantities of creamed honey for competition and local sale.

If you would like large quantities of creamed honey, you will need adequate equipment and will have to use the complete Dyce process for control of fermentation and crystallization.

## EXTRACTED (LIQUID) HONEY

Most beekeepers produce extracted honey; management of the bees is simpler and most consumers seem to prefer liquid honey. In addition, if you decide to produce creamed or chunk honey you need liquid honey. All things being equal, bees will produce more extractable honey than they will honey in the comb for you to harvest. Extracted honey is more economical to produce since combs used for extracted honey can be reused over several seasons.

Production of harvestable amounts of extracted honey requires colonies that are strong and do not swarm. Supers of drawn comb or foundation can be added as needed. The foundation should be reinforced as described previously.

Extracted honey supers are added above the existing brood area of a colony using a queen excluder or not, according to personal preference. You should add excess super space to colonies early in the season (oversupering) to maximize honey storage. Some beekeepers prefer to undersuper as the nectar flow wanes to aid in eventual honey removal and conservation of supers. To ensure a honey crop from single floral sources, previously filled supers need to be removed and colonies resupplied at the beginning of the nectar flow of a desired source; otherwise supers will likely contain a variety of floral sources honey.

The sections that follow largely detail management for the production of extracted honey.



Folks of all ages sampling the many flavors of extracted honey at a Mid-Atlantic festival. (Courtesy Maryann Frazier)

## Honey Removal and Processing

### REMOVING HONEY FROM THE COLONY

When removing the honey crop during the summer, be sure to leave adequate stores for the bees in case of a lack of a fall crop. A good rule is to leave a super full of honey with the bees at all times. Removing the fully capped supers before the honey flow has ceased is less likely to initiate robbing behavior. Intense robbing may occur if you wait to remove all of the supers until after the flow is over. Also, removal of the spring and summer honey crop just before the start of the goldenrod flow will allow you to keep the honeys separated by flavor. Usually summer honeys are lighter and milder in flavor compared to the darker, richer flavored fall honeys. Fall honeys often crystallize very rapidly, which could create several problems at extraction time if you wait to remove the entire crop at once. The fall honey crop should not be removed until after a killing frost. Ideally, frames and supers should be removed when they are fully capped, but they must be at least three-quarters capped before they are removed (Figure 59). Try to keep the harvest of partially capped frames to a minimum; otherwise you may have problems with high-moisture honey.

You can use several different techniques to remove the supers from the colonies, depending on the size of your operation. Use smoke sparingly when removing combs and/or supers because of its effect on the flavor of the honey. When harvesting only a few combs or supers of honey, shaking and/or brushing the bees from the combs may be the most practical method. To do this, open the lid and



Figure 59. A fully capped frame of honey ready to be removed from a colony and extracted. (Courtesy Dewey Caron)

smoke the bees lightly. Remove one frame at a time and, holding each tightly by the ends of the top bar, give it one or more quick shakes downward in the air above the open colony or within an open space of the super to remove most of the bees. The remaining bees can be brushed off the comb with a brush or a clump of grass in front of the hive. Place the harvested frames in covered supers to avoid robbing.

An alternative inexpensive, low-tech method of removing honey supers is to use a bee escape. Use of bee escapes requires two trips to the apiary—one to put on the escapes and the other to remove the honey. Two different types of escapes are commonly used today (Figures 60 and 61). The Porter bee escape is a metal or plastic device placed in the hole of the inner cover. The inner cover is then placed between the supers to be removed and those to be left on the bees. The triangular bee escape is the size of an inner cover fitted with two sets of triangles that act as a kind of maze. It is placed in the same

position as described above. In both cases the escapes act as one-way doors, allowing bees to move down but not back up into the supers once they are below the escape. Because they allow only one bee at a time to pass through the escape, Porter bee escapes are slow and can sometimes become clogged. This is not a problem with triangular escapes; however, they are more costly. The escapes are usually left on the colonies for 2 or 3 days to give the bees enough time to vacate the supers. Cool night temperatures are necessary to entice the bees to leave the supers to join the warmer brood below. If the supers are not bee tight, the honey above the escape boards will likely be robbed out by other colonies. If the humidity is high when the escapes are on the colonies, the honey may pick up some moisture. When even a small amount of brood is present in the supers, bees will remain with the brood and the escapes will not work, so the remaining bees must be shaken or brushed off.

Bee escapes work very well if used in combination with queen excluders. The excluder prevents the queen from laying in the honey supers, and when it is time to remove the honey, a bee escape (and inner cover if using a Porter bee escape) is substituted for the excluder. The easiest time to remove supers of honey cleared of bees with a bee escape is in the early morning before the bees are flying.

A third alternative is to use a chemical bee repellent and fume board. Chemicals used for removing honey include: benzaldehyde (oil of almond), butyric anhydride (Bee-Go<sup>®</sup>), and an oil/herb mixture (Fishers Bee-Quick<sup>®</sup>). Sprinkle a few drops of the chemical on a fume board, which is made by stretching a heavy piece of cloth over a frame that is the size of the inner cover. Cover the top with a piece of sheet metal to reinforce it and paint it black so that it absorbs heat from the sun. Place the fume board over the full supers. The fumes drive the bees downward. Blowing a few puffs of smoke over the top bars before adding the fume board will start the bees downward so they are less likely to become confused. The board should remain on the super only long enough to get the bees out, usually 3 to 5 minutes under ideal conditions.

Benzaldehyde works best at temperatures of 65°F (18°C) to 80°F (26°C) and is especially efficient on cool, cloudy days, whereas butyric anhydride works better from 75°F (24°C) to 88°F (31°C).



**Figure 60.** Porter bee escape is placed in the opening of inner cover to remove bees from honey supers. (Courtesy Dewey Caron)



**Figure 61.** Triangular escape placed between supers to be removed and those that will remain on the colony. (Courtesy Maryann Frazier)

Supers can be removed quickly from a large number of colonies with a high-volume, low-pressure, forced-air bee blower. Several commercial units powered by electricity or gas engines are available. Bee blowers have certain advantages over the other techniques including that combs do not have to be removed from the supers and bees can be removed from supers on cold, cloudy days when chemical repellents are not effective. The one real disadvantage is the cost of the unit.

### HONEY QUALITY

The quality of honey is affected by many different factors from the time it is removed from the colony until it is sold for human consumption. Whether the operation is small or large, producing a final packaged product that is of highest quality and attractive to the consumer is important.

Honey is considered at peak quality just after it is sealed in the comb by the bees. Proper handling during extraction and processing can produce liquid honey with only a slight loss of quality. While some consumers want raw or unprocessed honey (liquid honey that has not been filtered or heated), most market outlets require honey with a long shelf life. Thus, straining and some heating are advisable to delay granulation and prevent fermentation. The final product should be well strained, low in moisture, free from foreign flavors and impurities, and should retain its original delicate flavor and aroma. Other factors that lower the quality of the final product are excess air bubbles, pollen, and bits of wax incorporated into the honey during extraction.

Honey quality is affected most by heating and moisture content. At no time during processing should the honey be overheated. Excess heat chemically breaks down the levulose sugar, darkening the honey and eliminating the natural, volatile flavors that make honey unique. Honey is hygroscopic—it readily absorbs moisture from moist air and loses it to dry air. Moisture even passes through the wax cappings. So, the degree of ripeness at the time the honey is removed from the colony is largely related to the prevailing atmospheric humidity. Absorption of moisture lowers the grade and shelf life of the honey. High-moisture honey may ferment. After honey supers are removed from the colony, they should be held in a warm, dry area until extraction. The best time to remove excess moisture from honey,

if necessary, is while the honey is still in the comb. Either store the supers in a warm room at 75°–80°F (23–26°C) for a couple of days or stack them over a light bulb so that the heat passes up through the frames and warms the honey. Shield the light bulb so that honey and wax will not drip directly onto the bulb. An electric fan can be used to circulate the air in the room. Alternatively, you can use a clean vacuum cleaner to force air directly through a stack of supers; cut a hole in a super just large enough to permit the entry of the vacuum hose. Above this super, stack seven or eight supers of honey and turn on the vacuum so that it will force a large volume of warm, dry air through the combs. The amount of moisture removed will be related to the relative humidity and volume of circulating air. In large commercial operations, supers usually are placed in hot rooms before extraction. Warming honey will also speed up the extraction process. Honey held for a few days at room temperatures between 80°F (26°C) and 90°F (32°C) is ideal for quick complete extraction.

### EXTRACTION TECHNIQUES

Removing honey from the combs is difficult for the hobbyist since there is no simple, neat, and inexpensive way of doing so. The most primitive way of removing honey from the cells (destruct harvest) is to cut the combs from the frames and let the honey drain from the cells. To expedite the process, put pieces of honey-filled comb in a fine mesh bag then crush the combs and squeeze the honey out by hand. Then strain the final mixture through a coarse sieve or cloth such as cheesecloth.

The best method of producing liquid honey (non-destruct harvest) requires an extractor that uses centrifugal force to spin the honey from the cells. Various types and sizes of honey extractors are manufactured commercially. You may purchase an extractor, rent the equipment, find a beekeeper who does custom extracting, or build an extractor.

The first step in extraction is the removal of wax cappings. Uncap both sides of the honey-filled combs with an uncapping fork or sharp knife heated by electricity, steam, or by dipping it in hot water. Cut a thin layer of wax and honey from the surface of each comb with a back-and-forth sawing movement while you hold the knife against the top and bottom bars of the frame (Figure 62). First uncap one side, then turn the frame and uncap the other side.



**Figure 62. Wax cappings are removed from a honey comb with a hot knife. (Courtesy Dewey Caron)**

Pivot the end bar of the frame on the point of a nail supported by a strip of wood lying across the top of the container that receives the cappings. Hold the frame at an angle so the cappings fall free of the comb into the container below. Use an uncapping fork (also termed a cappings scratcher) to break open the cappings in the low areas of the comb not reached by the knife. Power uncappers with vibrating knives and automatic uncapping machines are available for large commercial operations.

Since the cappings contain a large amount of honey after they are cut from the combs, having some way of separating the honey from the wax is important. Allowing the cappings to drain into a screened box or wire basket is a convenient option for the small operator. The simplest uncapping box for draining the cappings is made from a clean hive body with a screen or queen excluder attached at the bottom or a metal/plastic container fitted with a screen insert to allow honey to pool below the cappings suspended on the screen. This unit is placed over a tank so that the honey is collected below. In larger operations, capping melters or spinners are used for reclaiming the honey.

Small-scale beekeepers often use a two- or four-frame basket extractor, which may be either a reversible or nonreversible type. Place the uncapped combs vertically in the baskets that support them. In the nonreversible type, you must reverse the combs by hand to extract the honey from the other side of the comb. Reversible extractors have baskets that pivot to extract first one then the other side of the comb without lifting and reversing frames. Either the

hand- or power-driven extractors are turned slowly at first. If the extractor is turned too rapidly, the weight of the honey may break the combs. The combs are spun until about half the honey is removed from the first side. Then the combs are reversed and spun until the second side is completely extracted. Finally, the combs are reversed a second time and the remaining honey from the initial side is removed. The time required to throw honey from the combs depends on the density and temperature of the honey. Watch the side of the tank to see when the honey stops flowing from the combs to determine when extraction is complete.

Large radial extractors holding from six to eighty frames are used in part-time and commercial operations. Combs do not have to be reversed when using a radial extractor since honey is thrown out of both sides at the same time. To achieve this, the combs are arranged in the extractors like spokes in a wheel, with the top bars on the outside. Radial extractors must be spun at a high rate of speed, so well-constructed frames and secure combs are a must.

After the honey is extracted, it contains air bubbles, pollen, and bits of wax. You can avoid excessive pollen by keeping brood combs out of the honey supers. Strain the honey through several layers of cheesecloth or a single layer of nylon after extracting it from the combs. This procedure removes most impurities and fragments of wax. Honey will absorb odors and flavors rapidly if the materials that produce them are not strained from the honey. Unless most or all of the wax has been removed during extraction, the honey's flavor may be impaired, especially if during packing the honey is heated beyond the melting point of wax. After straining, keep the honey in a settling tank for 2 to 3 days to allow most of the air bubbles and small foreign particles to rise to the top. The resulting foam should then be skimmed off before bottling. Use a honey gate at the bottom of the tank for filling jars or cans.

In commercial operations, the honey normally is pumped through large-diameter pipes with a lower geared honey pump from the extractor(s) into a sump tank where most of the wax and impurities are removed by a series of baffles. Larger beekeepers usually then sell or store their honey in 5-gallon metal cans/plastic buckets or drums holding 55 gallons.

## STORAGE OF HONEY

Storage temperatures and the length of storage can affect honey quality. Changes in processed honey are kept to a reasonable level if the honey is stored at temperatures of 70°–75°F (21°–24°C). Unprocessed honey is best stored below 50°F (10°C). Even at room temperature, honey gradually becomes darker and changes flavor and composition. Differences will be visible in less than one year. Both sunlight and artificial light further affect honey stored in clear glass bottles. For long-term storage, keep liquid honey in a freezer at 0°F (–18°C).

Keep only finely crystallized or creamed honey in a refrigerator or in similar cool environments. Refrigerator temperatures cause extracted honey as well as honey in comb to granulate very quickly.

## GRANULATION

Crystallization of honey is a natural process that does not indicate spoilage. Nearly all kinds of liquid honey will crystallize in time. The rate of crystallization is related to honey composition, storage conditions, and the amount of heating and filtering. Some honeys granulate uniformly throughout, while others will leave a liquid portion at the top. The faster honey granulates, the smaller the crystals will be. Slower granulation produces large, coarse crystals.

Honey is a supersaturated solution (containing more dissolved sugar than can normally remain in solution) composed primarily of two sugars, glucose (dextrose) and fructose (levulose), dissolved in about 17 percent water. Such solutions are more or less unstable and in time will return to the stable saturated condition with the excess material coming out of solution. During granulation, glucose separates from the liquid phase as crystals, while the other sugars remain in solution. As crystallization proceeds, the moisture content of the liquid phase increases, producing a favorable medium for fermentation. Honeys high in glucose crystallize rapidly; those high in fructose granulate very slowly. The ratio of glucose to fructose reflects that of the floral sources worked by the bees.

Heating and filtering delay crystallization. Heating dissolves sugar crystals that may be present in the honey and facilitates filtering, which removes tiny particles (pollen grains, wax, impurities, and so forth) on which crystals form. Low-moisture honeys granulate more slowly than high-moisture honeys.

The most favorable temperature for granulation is 57°F (14°C). Storing honey at room temperature will delay granulation. Small quantities may be frozen for several years before crystallization takes place.

## RELIQUEFYING GRANULATED HONEY

Honey with coarse, gritty crystals is undesirable to the consumer. To reliquefy, place containers of crystallized honey in a hot, dry chamber or in a hot-water bath until all crystals are completely liquefied. If you use a dry chamber, the labels on the containers will not be damaged. Do not heat the honey higher than 145°F (63°C) because it scorches easily. Buckwheat honey may burn at 140°F (60°C). Honey must be cooled as soon as it becomes clear to prevent discoloration and loss of flavor. When heated in 60-pound cans or buckets kept right side up, you must stir the honey frequently; otherwise, the honey next to the outside of the can will be overheated before the center is liquid. If you place the container in a hot water bath, the water should come near the top of the container.

## FERMENTATION

Sugar-tolerant yeasts occur naturally in honey. If they are not killed by heat, they can cause fermentation when honey moisture levels exceed 17 percent. High moisture levels can result from extracting honey that is not fully capped by the bees, allowing honey to absorb moisture during processing and storage, or during granulation. Fermentation usually occurs after granulation. Since more moisture is in the top layers of crystallized honey than in the bottom layers, fermentation begins at the top of the containers and works downward.

The yeasts develop on the glucose and fructose of the honey, producing alcohol and carbon dioxide. The alcohol in the presence of oxygen is further broken down into acetic acid and water, giving the honey a sour (vinegar) taste. The first signs of fermentation are whitish streaks appearing in granulated honey and honey leaking from the container. As the honey is heated, considerable foaming will occur. The degree of spoilage or effect on flavor and quality depends on the length of time fermentation is allowed to proceed before being stopped by heating.



Storing honey below 50°F (10°C) or above 80°F (26°C) will prevent fermentation indefinitely. Lower temperatures are preferred because higher temperatures can cause deterioration in honey color and flavor. Honey heated at 145°F (62°C) for 30 minutes will be safe from fermentation if protected from further yeast contamination. Higher temperatures (155°F to 160°F or 68°C to 70°C) are sometimes recommended, but only for a few minutes. Failure to lower the high temperatures quickly will result in a loss of production quality. Always heat honey in a double-jacketed heating vat to avoid contact with direct heat. Have at least 1 inch of water around the bottom and sides of the container. This ensures circulation of the hot water around the bottom and prevents scorching the lower honey layer by direct heat. Keep the water level near the top of the container and loosen the container's lid to allow for expansion.

### PACKAGING AND LABELING

Honey is packed and marketed in a wide variety of containers. Bee supply catalogs show containers in many shapes and sizes suitable for all types of markets. A common retail package for liquid honey is the queenline-type glass jar, which is available in a number of sizes from ½ pound up to 4 pounds. In some areas the canning jar is popular, holding ½ pint, pint, and quart. One-piece lids are available for these jars. Numerous round jars will hold from 4 ounces up to 5 pounds of honey. Plastic containers are becoming more popular and are available in many shapes and sizes including the queenline-type. Novelty containers include glass hexagonal shapes and antique styles, as well as plastic squeeze cylinders, skeps, and the ever-popular honey bear. Honey, in larger quantities, can be sold in plastic pails and jugs that hold from 3 pounds up to 2 gallons. The 5-gallon (60-pound) bucket is a very common way to package honey for sale to the food industry. One of the largest containers is the 55-gallon drum with a food-grade lining.

Honey to be packed can be heated to prevent fermentation and granulation in order to extend its shelf life. Wash and air-dry all glass containers before filling. For ease in filling, the honey should be warm. You should hold the containers at an angle to let the honey run down the side to prevent the incorporation of air bubbles. Otherwise, foam and bubbles will collect on the top surface of the honey,

making an unattractive appearance. Fill glass jars above the bead that runs around the jar. Fill all containers so that there is no gap between the bottom of the lid and the surface of the honey. Avoid overfilling. Wash off any honey that spills on the outside of the container or onto the threads. A sticky container is bad enough for the customer but becomes even less attractive when coated with dust while sitting on the shelf.

All honey to be sold, as well as honey that will be given away, should have an attractive label. A simple design with two or more colors that complement the color of the honey is desirable. Many different attractive labels are available from bee supply dealers (see appendix). Such labels can be imprinted with your name and address for a slightly higher fee.

All labels need to follow the federal label laws. State laws generally follow the federal laws. You can obtain a copy of both federal and state laws from your state Department of Agriculture. It is important to have a copy of these laws before designing a label or even using the pre-printed labels available from bee supply dealers. Various exemptions exist for small or oddly shaped containers. In general, a label must have the following:

- The word "honey" must be very visible—the largest letters on the label. If you can show that a floral source is the predominant one, usually done with a pollen analysis, you can name this source. Otherwise "wildflower" would be the only designation (but floral source is not required). It is allowable, for example, to say "contains clover" or "contains basswood" if you are certain of a possible floral source.
- The net weight must be in the lower third of the front label in easy-to-read type. If the net weight is less than a pound, it can be stated in ounces and grams. If the net weight is 1 pound or over, it must be stated in pounds and equivalent ounces and in grams. For example: 16 oz (1 lb) 454 g. Above 4 pounds, stating ounces is not necessary, but grams or kilograms (kg) must be used.
- The law requires that each section of honey placed in a container (section comb or cut comb honey) be marked with the minimum net weight in ounces and the name of the producer or seller. Net weight is usually 1 ounce less than the gross weight (1 ounce being allowed for the weight of the section's wood).

- The label must have contact information, that is, your name as producer. Your name and address are required, but telephone number is optional. If you bought honey from someone else and packed it, you must state “packed by” and your name. If you bought imported honey, the countries of origin must be stated. The contact information must be in a type size at least  $\frac{1}{16}$  inch tall.
- Other terms occasionally seen on honey labels include “raw,” “unfiltered,” “unheated,” or “natural.” The word “organic” may not be used since the word “organic” is no longer just a description. Organic products must be certified. If you use the word “healthy” on a label you must use the nutritional label already prepared for honey. A nutritional label for honey is available from bee supply dealers.
- If such descriptive terms are used, they designate that honey has not been heated above about 100°F (37°C) nor passed through a commercial filter. Letting honey settle to remove particles of wax and parts of bees from the extracting process is permitted and extends shelf life by delaying granulation.

## Marketing

There are three basic approaches to marketing the honey crop. With only a few colonies, you can easily sell all of your honey from the home to relatives, neighbors, and other members of the community. As the size of your operation increases, you will have to find other market outlets. Local groceries, fruit stands, health food stores, and roadside markets are potential outlets to explore. When even larger quantities are produced, the beekeeper may have to pack in large bulk containers and sell directly to wholesale dealers and packers. This method of selling is the least profitable. Many of the larger honey producers belong to the Sioux Honey Cooperative.

Most small beekeepers sincerely try to provide their customers with a quality pack in a clean, attractive container. When they do a good job, their customers return regularly, and the beekeepers have no problem selling their entire crop. To have repeat patronage, it is better for beekeepers to sell their crop gradually throughout the

year than to try to market all the honey they produce soon after it is harvested.

Honey sold directly to the consumer by the producer can return a fair amount of profit. Unfortunately, small beekeepers frequently fail to sell the honey crop at a fair price. Many fail to consider the demands on their time and energy as well as overall investment, since they think of their operation as an enjoyable hobby rather than as a business. If you sell your honey at too low a price, you are doing a disservice to yourself and to other beekeepers in your locale.

The best way to promote honey sales is first to produce a high-quality pack, then discover ways to promote your product. Where permitted, a “Honey for Sale” sign can be displayed in front of your home. You need to monitor honey displays in shops and at stands so that the display is kept clean and attractive. Any honey that has started to crystallize must be replaced with freshly packed honey. Honey that crystallizes rapidly is best made into creamed honey. In addition, it pays to talk to people about your bees and their interesting social life. Speaking to local service organizations and garden clubs, as well as having articles in local newspapers, will enhance your visibility for marketing purposes. Attending events where you can display an observation hive that attracts attention, give taste samples of your honey, and hand out recipes also contributes to successful promotion.



**Honey is successfully sold at many farm markets such as this one. Farm markets vary in appearance and the quality of products they sell, so be selective about the markets you choose to sell your honey. (Courtesy Dewey Caron)**

## Pollination

Honey bees are essential in the production of several fruit, vegetable, and legume seed crops grown in the Mid-Atlantic region. Lack of adequate pollination often results in low yields and small or misshapen fruits. Many growers underestimate their pollination needs. It is likely that yield and quality of some crops suffer every year from inadequate pollination. To date, no satisfactory substitute for bee pollination has been found for any major insect-pollinated crop. In the case of most crops, large numbers of bees must be present on the bloom to produce a commercial crop.

Pollination as a business offers additional opportunities to make money from your bees. Beekeepers located where they can produce a crop of honey and also rent bees for crop pollination can build more security into their businesses, especially for those years when the honey crop fails.

### Moving Bees

Beekeepers must recognize several possible risks and problems associated with moving bees for pollination. At least one day before moving colonies, secure hive bodies together with wide staples or plastic or metal bands. The best time to move colonies is around dusk, when most of the bees have returned to the hive and are no longer flying. Many beekeepers move their colonies during the night, arriving at their destination at daybreak. Waiting to move colonies until daybreak is less desirable because increasing light intensity and rising temperatures put additional stress on colonies. A cool, rainy day is also an appropriate time to move bees at any hour, so long as the bees are not flying.

The entrances of hives are normally closed with wire screen while bees are in transit. Entrance screens are about 4 inches wide and as long as the hive entrance. Before loading, smoke the hive entrances and push the loosely folded V-shaped entrance screens into place. Seal shut all other hive openings. Some beekeepers make long-distance moves without closing hive entrances. This approach is helpful during very hot weather and when not traveling through large cities. Colonies are loaded during the night, with the vehicle engine running. Vibrations

from the motor calm the bees after the colonies are placed on the truck. A better approach is to cover the entire load with netting or plastic screen. Some beekeepers use trailers to move bees (Figure 63). Some are even modified so that the bees can remain on the trailers year-round, making the moving of colonies possible without lifting the hives.



**Figure 63.** Colonies on trailer moved into field for cucumber pollination. (Courtesy Dewey Caron)

If you need to move colonies during hot weather, you must screen entrances and you will need additional ventilation to prevent suffocation. Top-moving screens that cover the entire colony and provide 2 to 3 inches of clustering space are ideal. These screens replace the regular hive cover. Cover an empty shallow super or similar wooden frame with window screen or 8-mesh/inch hardware cloth and place it on the hive with the screen side on top. Wetting the load down with water is also beneficial.

Stack the hives on the truck so that all colonies are sufficiently ventilated. Place the hives as close together as possible to keep the load from shifting, and securely tie down all stacks of hives.

Commercial beekeepers who specialize in moving colonies use migratory lids so they can stack hives tight against each other; they nail bottom boards in place and keep colonies on pallets—sometimes the pallet replaces the bottom board.

## When to Move Bees on to the Crop

Taking colonies into the target crop for pollination at the correct time will greatly enhance pollination. If colonies sit too long in a crop before it starts to bloom, foragers may become locked in on other blooming plants, hindering maximum visits to the crop to be pollinated. Place colonies in the crop only after the flowers become attractive to bees. In some tree fruits, a 10 to 25 percent bloom is recommended (Figure 64). However, if primary blossoms produce the choice fruit, as in apples for example, bees should be present either at the start of bloom or when the king bloom on the south side of the tree starts to open.



**Figure 64. Strong colonies of bees strategically placed in apple orchard at 10 percent king bloom. (Courtesy Maryann Frazier)**

When a colony is moved 2 or more miles, established flight patterns are broken. The field bees must again start to search for nectar and pollen and the colony spends a day or more establishing new flight patterns. A good supply of target crop bloom must be present when the bees begin searching for this new feeding area.

During cool weather in early spring, take the bees into the orchard when about 10 to 20 percent of the blossoms are open and leave them there until petal fall. In warm, sunny weather, you can move bees in when 25 percent of the flowers are open and then remove them shortly after full bloom; although most beekeepers and growers prefer that colonies remain until the end of bloom. In actuality, one good pollinating day with plenty of bees and pollinizer bloom present is enough for setting a crop in most tree fruits.

If bees in or near a crop are not working the target crop, moving them away and moving in other colonies from more than 2 miles away sometimes helps.

## Colony Strength

Package bees and small hives have proven inferior to strong overwintered colonies for pollination of early-season crops. The field bee population generally is correlated with the amount of brood in the hive. In packages and weak colonies, too many bees must remain in the hive to keep it warm and raise the brood. Two weak colonies do not equal one strong colony. Swarm control, particularly in strong pollination units, is important.

### Colonies used for springtime pollination have the following minimum requirements:

- queenright
- one-and-a-half or two stories high
- four to six frames of brood
- enough adult bees to cover six to eight frames

Colonies rented for summer pollination also need to have a queen, an expanded brood population, and enough honey to sustain themselves. Generally, minimum colony strength should be in the range of six to eight frames of brood. Swarm control is less of a management concern. A source of clean (uncontaminated by pesticides) water is a must.

Beekeepers who rent weak or dead colonies of bees tarnish not only their own reputation but also that of other beekeepers in the state. Beekeepers who rent bees should attempt to develop colonies into the most efficient pollinating units in time to do the job. Some growers may ask beekeepers to open a few randomly selected colonies to demonstrate colony strength. In a few crops, payment is dictated by a random sampling of colonies for strength and a predetermined payment scale for percentage of colonies in different strength categories.

---

## Number of Colonies Needed

The rule of thumb for most crops is to start with one colony per acre. If the area is well populated with wild solitary bees, bumblebees, and/or honey bees, the number of colonies may be reduced. If the weather is so cold or wet as to restrict bee flight, more bees may be put in the crop. The number of colonies needed will vary with location, attractiveness of the crop, density of the flowers, length of the blooming period, colony strength, and competitive plants in the area. Crops adjacent to uncropped natural habitats generally will support larger populations of native pollinators and might thus require smaller numbers of supplemental honey bee colonies.

---

## Competitive Plants

Honey bees flying up to 2½ miles in all directions from a single hive have access to 12,500 acres. Competing bloom such as dandelions or other weed/cover crops in the area may be more attractive to the bees than the target crop. In addition, when bees are moved into a pollinating situation from an area where a particular weed predominates at both sites, they usually resume collecting nectar and pollen from the same species at the new location. Remove such bloom by mowing, using herbicides, or cultivating before taking in the bees. Where this is a continuing problem, you might need extra colonies for satisfactory pollination results. This is one reason why permanent hive locations within an orchard/crop are discouraged.

---

## Colony Distribution

Because the temperature and conditions within the hive determine, to a great extent, the activity of bees, location at the pollination site is very important. Place hives where they are protected from the wind and where they are exposed to the sun from early morning until evening. If such a spot is not available in or near the orchard/field, making one is worthwhile. A stack of boxes or bins makes good protection, if they are located properly.

Distributing single colonies throughout a field or orchard is time consuming, expensive, and unnecessary. Placing colonies in groups of four to

eight in favorable locations throughout a field or orchard will provide even distribution of bees. Pollination will likely be just as effective in large orchards/fields if groups of ten to twenty hives are strategically distributed in sunny, wind-protected spots well within the boundaries of the target crop.

---

## Effect of Weather

Weather is the key to maximum effectiveness of the pollinating force. Bees rarely fly when the temperature is below 55°F (12°C) or the wind is more than 15 to 20 miles per hour. The stronger the colony, the lower the temperature at which the bees may initiate flight. Strong colonies do little pollinating below 55°F (12°C); weak ones do little below 60°F (15°C). Cool, cloudy weather and threatening storms greatly reduce bee flights. In poor weather, bees foraging at more distant locations will remain in the hive and only those that have been foraging nearby will be active. Therefore, over an extended period of inclement weather, colonies may require greater distribution to ensure adequate coverage.

Poor weather conditions also affect plants. Spring frosts can kill fruit bloom, and temperatures of 40°F to 50°F (4°C to 10°C) retard pollen germination and tube growth. Fertilization failure may result. If the weather is hot and dry or windy, stigmas may dry out so that deposited pollen does not germinate. Pollen release may be hindered by prolonged rains. However, effective pollination can take place with surprising rapidity in warm, clear weather.

---

## Crop Characteristics and Needs

Each crop and often crop varieties have unique characteristics that may require different approaches. Growers and beekeepers must work together; cooperation and understanding each other's needs and problems are mutually advantageous.

Because most tree fruits are propagated by grafts, a solid block of one variety is genetically a single plant. Most varieties are self-sterile and therefore cannot be productive without pollen from a compatible variety. Growers make orchards productive by interplanting compatible varieties with coinciding blooming periods, providing bouquets of flowers from other varieties, or supplying the beekeepers with pollen to use in pollen inserts.

Apples, pears, and sweet cherries must receive pollen from another variety because their own pollen is not compatible. Because apples are quite attractive to bees in some areas, they attract many wild bees. When apples are insufficiently pollinated, they develop lopsided fruit; the apple is larger on the sides where the seeds have formed. For a full commercial crop, 5 to 10 percent of full bloom should set fruit.

Some pear varieties are capable of setting fruit without pollination (parthenocarpic fruit). However, large numbers of bees must be present to achieve adequate fruit set. Honey bees visit pears primarily for pollen. Since the nectar is very dilute and unattractive, pears pose more of a pollination problem than do apples. Honey bees work pears best when colonies are first put into the orchard. Therefore, colonies should be moved in at 25 to 50 percent bloom. Later, they tend to be attracted to competing flowers in the area. Use twice as many colonies as you would use for apples in the same locality.

Sweet cherries must be pollinated soon after the flower opens, as reproductive parts of the flower degenerate quickly. Therefore, colonies should be in the orchard at the start of bloom.

Leading commercial varieties of tart cherries are self-fruitful, so orchards may be planted in solid blocks of one variety. However, the pollen is heavy and sticky, so bee transfer is required. The blossoms are attractive and bees work them well.

Most commercial varieties of peaches and nectarines are self-fruitful and may be planted in solid blocks. Bloom is very attractive, so colonies of honey bees are not normally rented. In areas where wild bees are scarce and weather may reduce bee flights, it would be good insurance for growers to place colonies of honey bees in the orchard. The only major peach variety requiring cross-pollination is J. H. Hale.

Colonies should be present in plum orchards from first bloom until petal fall. Interplantings are considered a safeguard for all varieties. Prune types are partially self-fruitful, but the pollen from European plums often will improve set on the prune-plum. The blossoms are attractive to bees.

Honey bees are usually necessary for commercial production of highbush blueberries. Full pollination results in higher yields, larger berries, and earlier ripening. Blueberries yield nectar and pollen, but bees visit the flower predominantly for nectar.

Current varieties are self-fruitful but vary in attractiveness to honey bees.

Cranberries also require pollination by honey bees for adequate yield. It is a difficult crop to pollinate because flowers produce little nectar or pollen. Colonies deteriorate quickly when situated on cranberry bogs. Bees prefer almost any competitive bloom over the cranberry flower. Strong colonies are a must for producing commercial yields.

Cane fruits such as raspberries and blackberries require bee pollination. Generally, acreage planted to cane fruits is small in the Mid-Atlantic region. However, where high yields are desired and wild bee (bumble and solitary) populations are low, the rental of honey bee colonies is desirable at a rate of one colony per acre.

Most modern strawberry varieties are self-fruitful. The anthers that contain pollen circle the receptacle that contains the pistils. Some varieties have tall stamens, so the anthers are close to the stigmas and pollination can occur readily as leaves and flowers are moved by the wind. Additional movement of pollen by bees increases yield only slightly. Other varieties have tall receptacles and short stamens. Unless pollen movement in these varieties is aided by bees, pollination, yield, and size will be reduced, and many berries will be misshapen. Most growers would benefit from the consistent use of honey bees in their fields.

Commercial production of cucurbit crops requires bee pollination since two types of flowers are found on the vines, and the pollen is dense and sticky. Cucumbers, squash, pumpkins, and watermelons have separate male and female flowers, whereas muskmelons (cantaloupes) have male and hermaphroditic (perfect or bisexual) flowers. The sticky pollen of the male flowers must be transferred to the female flowers to achieve fruit set. Even with hermaphroditic flowers, commercial yields of muskmelon are not possible when there are few insect pollinators.

Cucurbit flowers are usually open and attractive to bees for only 1 day or less. The opening of the flower, release of pollen, and commencement of nectar secretion normally precede bee activity. Pumpkin and squash flowers usually open around daybreak and close by noon, whereas cucumbers, muskmelons, and watermelons open around 8:00 A.M. and remain open the entire day.

Pollination must take place on the day when the flowers open because pollen viability, stigmatic receptivity, and attractiveness to bees last only 1 day. Pumpkin and squash pollination is most effective in early morning, primarily before 9:00 A.M. In cantaloupes, cucumbers, and watermelons, pollination is most effective during late morning and early afternoon. Honey bees are normally most active in the field from 10:00 A.M. to 3:00 P.M., with peak flight occurring near noon. Honey bees are not as effective in pollinating squash and pumpkins as they are in pollinating the other cucurbits because the flowers close at noon.

Multiple bee visits of at least eight to twelve per flower are needed to produce marketable fruit in the cucurbits. When large populations of hybrid cucumbers are grown for machine harvesting, flowers should receive fifteen to twenty visits for maximum fruit set. In general, as the number of visits increases, so does the fruit set, number of seeds per fruit, and fruit weight. Fruit shape also improves up to a point as the number of visits increase. Cucumbers may be misshapen in spite of adequate pollination.

With vine crops, a high level of bee activity in the field is effective only over a few days due to fruit inhibition. As the number of fruit on the vine increases, the probability of additional well-shaped fruit developing decreases, even though optimum pollination conditions exist.

Pollination of lima beans normally occurs without the aid of an insect visitor. The anthers surround the stigma and shed their pollen upon it. Mechanical tripping is unnecessary to ensure adequate pollination. If the stigma is pollinated by an insect visitor before it is touched by its own pollen, cross-pollination will result. Most research to date has not conclusively shown significant increases in yield with bee visitation. However, some growers feel they benefit by having colonies of honey bees near their fields.

Bees work the lima bean flower well for nectar and obtain some pollen from it. Nectar is secreted at the base of the flower and is a source of fine-quality honey. Nectar secretion seems to be greatest when plants first come into bloom and remains intense for about a week.

Peppers, eggplants, and beans generally benefit from bee pollination, but few growers rent honey bee colonies. If yields are low or inconsistent,

especially if acreage is high, supplemental pollination by rented honey bee colonies is suggested. The subsequent crop should be evaluated to see if the addition of pollinators improves yield.

A few seed growers rent bee colonies in the Mid-Atlantic region. Some soybean varieties yield better with cross-pollination, but growers usually do not rent colonies. Such locations could be of benefit to beekeepers due to the added bonus of a possible honey crop.

---

## Pollination Contracts

A written agreement between beekeepers and growers when honey bee colonies are being rented for pollination services is highly recommended. Such a contract will help to prevent misunderstandings and thus ensure better pollination service. Key points that should be included in the contract are:

- Date of movement of bees into the crop, or the time relative to a certain condition of bloom, and the date on which bees are to be removed
- Location of crop
- Number and strength of colonies
- Pattern of colony placement
- Rental fee and the date(s) on which it is payable
- Grower agrees not to apply bee-toxic pesticides while bees are in the crop, but if necessary to do so, the beekeeper will be given 48 hours' notice
- Grower agrees to warn beekeeper of other spraying in the area
- Grower agrees to reimburse the beekeeper for any additional movement of colonies in, out, or around the crop
- Grower will provide right of entry to beekeeper for management of bees

For more information on pollination contracts and a contract template, visit the MAAREC Web site: [maarec.cas.psu.edu](http://maarec.cas.psu.edu) or contact your local cooperative extension office.

# Handling Beeswax and Pollen Trapping

## Rendering Beeswax

Most beekeepers accumulate beeswax in the form of cappings, old combs, and bits of wax. Too often, these sources of wax go to waste because the beekeeper does not go to the trouble of melting or rendering them. However, in recent years the value of beeswax has increased significantly and wax production can be a worthwhile part of any beekeeping operation. Generally, 1 to 2 pounds of wax can be obtained from every 100 pounds of extracted honey produced.

A solar beeswax extractor is a safe, efficient way of rendering wax with a minimum of effort and energy consumption (Figure 65). This extractor produces wax of high quality and eliminates the need for the sometimes hazardous job of rendering wax in the home or honey house.

A solar extractor, which is easy to construct, is a glass-covered box that uses the sun's heat to melt beeswax so it will separate from honey and other materials normally mixed with the beeswax (Figure 66). You can use the extractor to render old combs, cappings, burr comb, and other hive scrapings containing beeswax. It is also handy for removing beeswax from the queen excluders. Collect the cappings, old combs, and bits of wax in wire basket and place them on the sloping metal tray below the glass cover. A glass surface sloping about 15° will obtain maximum exposure to the sun. Honey and



**Figure 65.** Solar beeswax extractor positioned to receive maximum radiation from the sun and protection from prevailing winds. Placing the extractor on wheels allows it to be moved to face into the sun. (Courtesy of John Harchuck)

melted wax drain quickly to the storage pan below. The melted wax will flow more easily if you set the combs, excluders, and capping baskets on metal rods or angle iron so they are slightly raised above the floor of the melting tray. You may place a window screen across the pan's outlet so unmelted pieces of comb and other debris do not flow into the pan of molten wax. If the angle is not too steep, little or no dirt will flow into the catch pan. The collecting pan should have sloping sides so the wax cake can be removed easily.

Solar wax melters attain internal temperatures well above the melting point of beeswax, (about 145°F or 62°C) on warm, sunny days. In very hot weather, remove the rendered wax from the extractor regularly because the wax will darken if subjected to high temperatures for long periods. Place the solar wax extractor in a protected location on the south side of a building, or at least where it is protected against the prevailing winds, which can lower the temperature inside of the extractor.

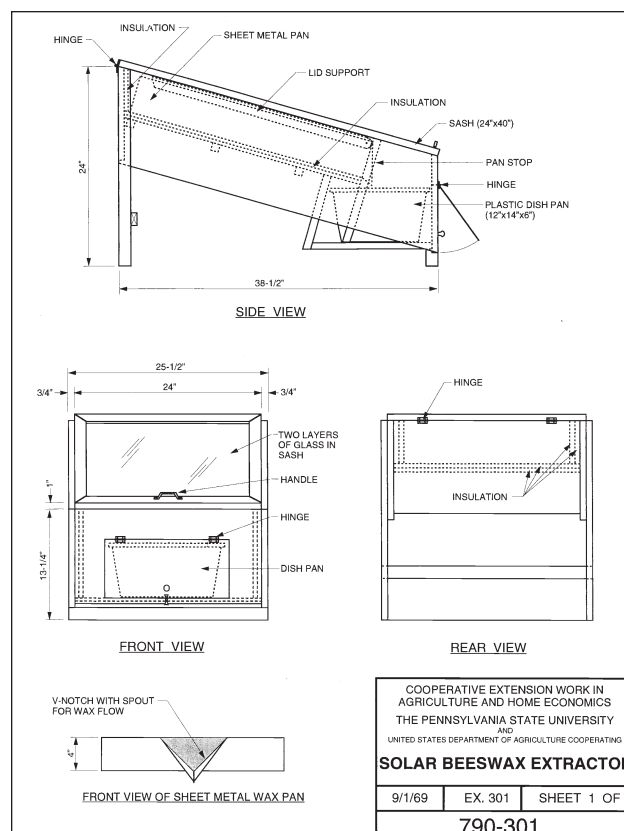

**Figure 66.** Plans for constructing a solar beeswax extractor.



Experience has shown that extractor efficiency can be improved by using a glass cover consisting of two panes of double-strength glass about  $\frac{1}{4}$  inch apart and by placing a piece of fiberboard insulation under the melting pan. This design helps to retain the absorbed heat.

The outside of the box should be painted black and the inside white. The size of the extractor needed depends on the amount of wax to be rendered. An extractor that is 2 feet wide and 3 feet long will handle all of the wax from up to sixty hives of bees. Since solar extractors are highly attractive to robber bees due to the odors given off by the warm honey and wax, they should be kept tightly closed except when being loaded or when the filled collecting pan is being removed.

The solar extractor eliminates the need to render old combs and cappings by melting the wax in containers of boiling water and then straining the mixtures through layers of cloth. In addition to being time consuming and messy, this method poses a continual fire hazard because the wax may boil over and run down to the heat source below. Plans for constructing a solar beeswax extractor are available on the MAAREC Web site: [maarec.cas.psu.edu](http://maarec.cas.psu.edu).

**CAUTION:** *Beeswax has a low flashpoint and should never be heated directly over an open flame.*

Beeswax has many practical uses. Dealers of beekeeping equipment and supplies trade foundation for beeswax. By filtering beeswax through nylon mesh, it can be easily cleaned and used for candles and cosmetics (hand cream and lotions for example) or molded into  $\frac{1}{2}$ -2-ounce blocks for sale to customers. Recipes for products using beeswax are readily available on the Internet or in publications (see "Sources of Information" in the appendix).

## Trapping Pollen from Colonies

Trapping pollen from your colonies during major pollen flows will ensure adequate supplies to feed back to your colonies whenever conditions warrant, as in early spring. To trap pollen effectively, force the field bees to enter the hive through an opening screened with either 5-mesh/inch hardware cloth or a  $\frac{3}{16}$ -inch diameter perforated metal plate. A double-screened grid is much more efficient than a single screen. When using a double screen, separate the layers by  $\frac{3}{16}$  to  $\frac{1}{4}$  inch and offset the openings.

In addition to having a grid that removes most of the pollen pellets from the bees, traps also contain a box or tray to collect the pellets. The collection container should also be covered with 7- or 8-mesh/inch screen to prevent bee entry. Also cover the traps to prevent rain from getting into the pollen. Making the tray or collection part of the trap from wood will eliminate condensation, and using copper screen on the bottom of the pollen-collecting container will help prevent mold in the collected pollen.

Pollen traps vary greatly in design and positioning on the colony. The size, shape, and arrangement of the parts, the location of the trap on the colony, the method of installation, and other factors can be varied to suit individual needs and circumstances. Traps mounted at the front of the hive (versus those situated below the hive itself) will give the cleanest pollen.

Pollen should be trapped from only strong, disease-free colonies during major pollen flows. Traps should be removed at other times. During major nectar flows, pollen trapping is unprofitable. The pollen trap should not be allowed to remain on any colony for more than a few days so the colony is not deprived of adequate pollen stores. Traps should collect from  $\frac{1}{4}$  to  $\frac{1}{2}$  pound per day. Solid, bee-tight hive equipment is necessary; otherwise, the bees will seek out any secondary openings to avoid passing through the pollen trap grid.

Pollen should be removed from the trap daily and cared for properly. Moisture in the collected pollen may be a serious problem during inclement weather and in areas of high humidity. Freshly trapped pollen is perishable and must be frozen or dried. Pollen properly dried can be stored for years in a closed container without appreciable loss in its food value. Fresh pollen can be placed in paper bags and stored in a deep freeze below freezing temperatures until needed.

Studies at the University of Guelph, Ontario, have shown that mixing two parts freshly trapped pollen with one part granulated sugar and packing it tightly into sealed containers is an effective way of storing pollen. Pollen stored in this manner does not require refrigeration and can be incorporated readily into pollen supplement formulae. It was found to promote excellent brood rearing after 2 years of storage at room temperature.

# Floral Sources

Honey production and colony development are directly related to floral sources in the immediate area of your apiary. Major nectar flows (sometimes termed honey flows) depend on a few plant species that yield nectar abundantly and are readily available. Besides the two or three main annual sources, there should be a great variety of minor plants yielding both pollen and nectar throughout the season to support the colonies between the main flows.

Large acreages of flowering plants are needed for bees to produce surplus honey. Planting crops just for their nectar and pollen yields is not usually economical. An acre of blooming plants rarely provides surplus honey for more than one or two colonies of bees. The value of land not being used for other purposes can be increased, if it is planted to some nectar-yielding plant such as sweet clover rather than left to grass and weeds.

Beekeepers should become familiar with the major floral sources of their area and when these

species bloom. From the standpoint of honey production, the most populous colonies produce the most honey. Thus, the essence of spring management is the development of strong colonies. Efficient management requires proper timing of colony development so that maximum populations will coincide with major nectar flows.

The Mid-Atlantic region has a great variety of nectar- and pollen-producing plants, as shown in the table below. The widespread distribution of plants such as dandelion, maple, sumac, blackberry, several species of clover, and goldenrod makes it possible to produce a crop of honey in almost any part of the region even within large cities.

One small general area in the high altitudes of Elk, McKean, Forest, Indiana, Cambria, Clearfield, and Somerset Counties of Pennsylvania has large amounts of Hercules Club (*Aralia spinosa*). This plant produces a large crop of bitter honey with a limited market but good wintering qualities.

## Primary and secondary floral sources in the Mid-Atlantic region.

COMMON NAME	SCIENTIFIC NAME	VALUE AS A NECTAR SOURCE	VALUE AS A POLLEN SOURCE
Skunk cabbage	<i>Symplocarpus foetidus</i>	—	minor
Elm	<i>Ulmus spp.</i>	—	minor
Willow	<i>Salix spp.</i>	minor	major
Crocus	<i>Crocus spp.</i>	minor	major
Maple	<i>Acer spp.</i>	minor	major
Cottonwood	<i>Populus spp.</i>	—	minor
Dandelion	<i>Taraxacum officinale</i>	major	major
Fruit bloom (apple, peach, pear, cherry, plum)		minor	minor
Wild cherry	<i>Prunus spp.</i>	minor	minor
Wild Mustard	<i>Brassica rapa</i>	minor	minor
Canola	<i>Brassica compestris</i>	minor	minor
Yellow rocket	<i>Barbarea vulgaris</i>	minor	minor
Strawberry	<i>Fragaria xananassa</i>	minor	minor
Black locust	<i>Robinia pseudo-acacia</i>	major	minor
Tulip poplar	<i>Liriodendron tulipifera</i>	major	minor
Brambles (blackberry, raspberry)	<i>Rubus spp.</i>	major	minor
Blueberry	<i>Vaccinium spp.</i>	major	minor
Huckleberry	<i>Gaylussacia spp.</i>	minor	minor
Cranberry	<i>Vaccinium macrocarpon</i>	minor	minor

**Primary and secondary floral sources... (continued)**

COMMON NAME	SCIENTIFIC NAME	VALUE AS A NECTAR SOURCE	VALUE AS A POLLEN SOURCE
Holly	<i>Ilex spp.</i>	major	minor
Yellow sweet clover	<i>Melilotus officinalis</i>	major	major
White sweet clover	<i>Melilotus alba</i>	major	major
Blue weed	<i>Echium vulgare</i>	major	minor
Alfalfa	<i>Medicago sativa</i>	major	—
Corn (field, sweet)	<i>Zea mays</i>	—	major
Basswood	<i>Tilia spp.</i>	major	—
Alsike clover	<i>Trifolium hybridum</i>	minor	minor
White Dutch clover (Ladino)	<i>Trifolium repens</i>	major	minor
Smooth sumac	<i>Rhus glabra</i>	minor	minor
Vetch	<i>Vicia spp.</i>	minor	—
Birdsfoot trefoil	<i>Lotus corniculatus</i>	minor	minor
Canadian thistle	<i>Cirsium arvense</i>	minor	minor
Wild carrot (Queen Anne’s lace)	<i>Daucus carota</i>	minor	minor
Milkweed	<i>Asclepias spp.</i>	minor	—
Cucurbits (cucumber, squash, pumpkin, cantaloupe, watermelon)		minor	minor
Button bush	<i>Cephalanthus occidentalis</i>	minor	minor
Catnip	<i>Nepta cataria</i>	minor	—
Chicory	<i>Chichorium intybus</i>	minor	minor
Star thistle (spotted knapweed)	<i>Centaurea maculosa</i>	minor	—
Sunflower	<i>Helianthus spp.</i>	minor	minor
Purple loosestrife	<i>Lythrum salicaria</i>	major	minor
Thyme	<i>Thymus spp.</i>	major	minor
Smartweed	<i>Polygonum spp.</i>	minor	minor
Red clover	<i>Trifolium pratense</i>	minor	minor
Wild bergamot (horsemint)	<i>Monarda spp.</i>	minor	minor
Wild marjoram	<i>Origanum vulgare</i>	minor	minor
Fireweed (willow herb)	<i>Epilobium angustifolium</i>	minor	minor
Pepperbush	<i>Clethra alnifolia</i>	minor	minor
Clematis	<i>Clematis spp.</i>	minor	minor
Bonset	<i>Eupatorium perfoliatum</i>	minor	minor
Lima bean	<i>Phaseolus lunatus</i>	minor	—
Soybean	<i>Glycine max</i>	minor	minor
Japanese knotweed	<i>Polygonum spp.</i>	minor	major
Joe Pie Weed		major	minor
Spanish needle	<i>Bidens spp.</i>	minor	minor
Staghorn sumac	<i>Rhus spp.</i>	minor	minor
Buckwheat	<i>Fagopyrum esculentum</i>	minor	—
Goldenrod	<i>Solidago spp.</i>	major	major
Aster	<i>Aster spp.</i>	major	minor

— of negligible value

## Glossary

- Abdomen**—the segmented posterior or third region of the body of a bee enclosing the honey stomach, intestine, reproductive and other organs, and stinger.
- Abandoning swarm**—an entire colony of bees that abandons the hive because of disease, wax moth, or other maladies.
- Adulterated honey**—any product labeled “Honey” or “Pure Honey” that contains ingredients other than honey but does not show these on the label. (Suspected mislabeling should be reported to the Food and Drug Administration.)
- Afterswarm**—a small swarm, usually headed by one or more virgin queens, which may leave the hive after the first or prime swarm has departed.
- Africanized bee**—a population of bees in the Americas, also called “killer” bees, which has resulted from importation of bees into Brazil from Africa in the mid-1950s known for their defensiveness.
- Alighting board**—a small projection or platform at the entrance of the hive.
- American foulbrood (AFB)**—a brood disease of honey bees caused by the spore-forming bacterium *Paenibacillus* (formerly *Bacillus*) *larvae*.
- Anaphylactic shock**—constriction of the muscles surrounding the bronchial tubes of a human, which can be caused by hypersensitivity to venom and result in sudden death unless immediate medical attention is received.
- Apiary**—an area where colonies of bees, and perhaps other beekeeping equipment, are located; also called bee yard.
- Apiculture**—the science and art of keeping honey bees.
- Apis mellifera***—scientific name of the honey bee found in the United States.
- Automatic uncapper**—automated device that removes the cappings from honey combs, usually by moving the frames between heated knives, metal teeth, or flails.
- Bacillus larvae***—former name of the bacterium that causes American foulbrood.
- Bait hive**—an empty hive or box, sometimes with a pheromone lure, used to attract swarms.
- Bee blower**—a gasoline or electrically powered engine with attached blower used to dislodge bees from combs in a honey super by creating a high-velocity, high-volume wind.
- Bee bread**—a mixture of pollen and nectar or honey collected by foragers and deposited in the cells of a comb to be used as food by the bees.
- Bee brush**—a brush used to remove bees from combs.
- Bee escape**—a device used to remove bees from honey supers and buildings by permitting bees to pass one way but preventing their return.
- Beehive**—a box or receptacle with movable frames, used for housing a colony of bees.
- Bee metamorphosis**—the three brood stages (egg, larva, and pupa) through which a bee passes before reaching maturity.
- Bee space**— $\frac{1}{4}$ - to  $\frac{3}{8}$ -inch space between combs and hive parts sufficient to permit unhindered passage of adult bees but too small for them to build comb or deposit propolis.
- Beeswax**—a complex mixture of organic compounds secreted by special glands located on the ventral side of the worker bee’s abdomen; used for molding six-sided cells into comb. Its melting point is from 144°F (62°C) to 147°F (64°C).
- Bee mite**—a parasitic arthropod that infests honey bee colonies. See also “varroa mite” and “tracheal mite.”
- Bee tree**—a tree with one or more hollows occupied by a feral (unmanaged) colony of bees.
- Bee veil**—a cloth or wire netting for protecting the beekeeper’s face, head, and neck from stings.
- Bee venom**—the poison secreted by special glands attached to the stinger of the bee.
- Benzaldehyde**—a volatile, almond-smelling chemical used to drive bees out of honey supers.
- Boardman feeder**—a device for feeding bees in warm weather; consists of an inverted jar with an attachment allowing access to the hive entrance.

**Bottom board**—the floor of a beehive; usually includes colony entry/exit.

**Brace/ burr comb**—bits of comb built between parallel combs, between comb and adjacent wood, or between two wooden parts such as top bars to fasten them together permitting workers to move easily within the nest.

***Braula coeca***—the scientific name of a wingless fly commonly known as the bee louse.

**Brood**—the collective term for all immature stages of bees: eggs, larvae, and pupae.

**Brood chamber**—the part of the hive in which the brood is reared; consists of one or more hive bodies and the combs within.

**Capped brood**—pupae whose cells have been sealed with a porous beeswax cover by mature bees to isolate them during their nonfeeding pupal period; also called sealed brood.

**Capping melter**—device used to liquefy the wax from beeswax cappings after they are removed (uncapped) from honey combs.

**Cappings**—the thin wax covering of cells full of honey; the cell coverings after they are sliced from the surface of a honey-filled comb.

**Castes**—the two types of female bees of a honey bee colony: workers and queen. (Sometimes drones are incorrectly included as a third caste—they are males.)

**Cell**—the hexagonal (six-sided) compartment of a honey comb.

**Cell bar**—a wooden strip on which queen cups are placed for rearing queen bees.

**Cell cup**—base of an artificial queen cell; made of beeswax or plastic and used for rearing queen bees.

**Chilled brood**—developing bee brood that have died from exposure to cold; commonly caused by mismanagement.

**Chunk honey**—honey cut from frames and placed in jars along with liquid honey.

**Clarifying**—removing visible foreign material from honey or wax to increase its purity.

**Cluster**—a large group of bees hanging together, one upon another for warmth and/or cohesion.

**Colony**—the aggregate of worker bees, drones, queen, and developing brood living together as a social family unit in a hive or other dwelling.

**Comb**—a mass of six-sided cells made of wax by honey bees in which brood is reared and honey and pollen are stored; composed of two layers united at their bases (also termed beeswax comb or honeycomb).

**Comb foundation**—a commercially made structure consisting of a thin sheet of beeswax (sometimes laminated on a plastic sheet) with the cell bases of worker cells embossed on both sides in the same manner as they are produced naturally by honey bees.

**Comb honey**—honey produced and sold in the comb, in either thin wooden sections (4 x 4 inches or 4 x 5 inches) or circular plastic frames.

**Creamed (Crystallized) honey**—honey that has been allowed to crystallize, usually under controlled conditions, to produce a tiny crystal that gives the honey a creamy texture.

**Crimp-wired foundation**—comb foundation into which thin crimped wire is embedded vertically during foundation manufacture.

**Cross-pollination**—the transfer of pollen from an anther of one plant to the stigma of a different plant of the same species.

**Crystallization**—see “granulation.”

**Cut-comb honey**—comb honey cut into various sizes, the edges drained, and the pieces wrapped or packed individually.

**Decoy hive**—see “bait hive.”

**Dancing**—a series of repeated movements of bees on comb; round and wag-tail (or wagging) dance are used to communicate the location of food sources and potential home sites.

**Demaree**—the method of swarm control that separates the queen from most of the brood within the same hive.

**Dequeen**—to remove a queen from a colony.

**Dextrose**—one of the two principal sugars found in honey; forms crystals during granulation; also known as glucose.

**Dividing**—partitioning a colony to form two or more units termed divides or splits.

**Division board feeder**—a wooden or plastic compartment suspended in a hive like a frame to hold sugar syrup to feed bees.

**Double screen**—a wooden frame,  $\frac{1}{2}$  to  $\frac{3}{4}$  inch thick, with two layers of wire screen used to separate two colonies within the same hive, one above the other. An entrance is cut on the upper side and placed to the rear of the hive for entry/exit to the upper colony.

**Drawn combs**—combs with cells built out by honey bees from a sheet of foundation.

**Drifting of bees**—the failure of bees to return to their own hive in an apiary containing many colonies. Young bees tend to drift more than older bees, and bees from small colonies tend to drift into larger colonies.

**Drone**—the male honey bee.

**Drone comb**—comb measuring about four cells per linear inch where the queen typically lays unfertilized eggs that become drones.

**Drone layer**—an infertile or unmated laying queen or queen that has run out of sperm; she is able to produce only unfertilized eggs.

**Drumming**—rhythmic pounding on the sides of a hive to make the bees ascend into another box/hive body placed over it.

**Dwindling**—the rapid dying off of old bees in the spring; sometimes called spring dwindling or disappearing disease (because a pathogen may be involved).

**Dysentery**—an abnormal condition of adult bees characterized by severe diarrhea; usually caused by starvation, low-quality food, moist surroundings, or nosema infection.

**Electric embedder**—a device allowing rapid embedding of wires in foundation with electrically produced heat.

**European foulbrood (EFB)**—an infectious brood disease of honey bees caused by the bacterium *Melissococcus* (formally *Streptococcus*) *pluton*.

**Extender (grease) patty**—a mixture of vegetable shortening and granulated sugar placed above or below the brood area for mite control; sometimes includes the antibiotic Terramycin.

**Extracted honey**—liquid honey removed from the comb usually by centrifugal force.

**Feral bees**—unmanaged colony of bees living in a tree hollow or other enclosed structure.

**Fermentation**—a chemical breakdown of honey caused by sugar-tolerant yeast; associated with honey having a high moisture content.

**Fertile queen**—a queen, inseminated instrumentally or mated with a drone, which can lay fertilized eggs.

**Field bees**—worker bees at least three weeks old that work (forage) outside the hive to collect nectar, pollen, water, and plant saps for making propolis.

**Flash heater**—a device for heating honey very rapidly to prevent it from being damaged by sustained periods of high temperature.

**Food chamber**—a hive body filled with honey for winter stores.

**Foulbrood disease**—see “American foulbrood” or “European foulbrood.”

**Foundation**—see “comb foundation.”

**Frame**—four pieces of wood/plastic (top bar, a bottom bar, and two end bars) designed to hold foundation/drawn comb.

**Fructose**—the predominant simple sugar found in honey; also known as levulose.

**Fumidil-B**—the trade name for Fumagillin; a chemotherapy used in the prevention and suppression of nosema disease.

**Fume board**—a rectangular frame, the dimensions of a super, covered with an absorbent material such as burlap, on which is placed a chemical repellent to drive the bees out of supers for honey removal.

**Glucose**—one of the two principal sugars found in honey; forms crystals during granulation; also known as dextrose.

**Grafting**—removing a worker larva from its cell and placing it in an artificial queen cup in order to have the bees rear it as a new queen.

**Grafting tool**—a needle or probe used for transferring larvae in grafting of queen cells.

**Granulation**—the formation of sugar (glucose) crystals in honey.

**Hive**—a human-made home for bees.

- Hive bee**—an adult worker performing tasks within the hive during the first 3 weeks of her adult life.
- Hive beetles**—see “small hive beetles.”
- Hive body**—a wooden box that holds ten (sometimes eight) frames.
- Hive stand**—a structure that supports the hive.
- Hive tool**—a metal device used to open hives, pry frames apart, and scrape wax and propolis from the hive parts.
- Honey**—a sweet viscid material produced by bees from the nectar of flowers, composed largely of a mixture of glucose and fructose sugars dissolved in 15–19 percent water; contains small amounts of sucrose, mineral matter, vitamins, proteins, and enzymes.
- Honeycomb**—see “comb.”
- Honeydew**—a sweet liquid excreted by aphids, leafhoppers, and some scale insects that is collected by bees, especially in the absence of a good source of nectar. Finished honey is sometimes called forest honey.
- Honey bee**—common name for *Apis mellifera*.
- Honey extractor**—a machine that removes honey from the comb cells by centrifugal force.
- Honey flow**—a time when nectar is plentiful and bees are capable of making and storing surplus honey.
- Honey house**—building used for extracting honey and storing equipment.
- Honey pump**—a pump used to transfer honey from a sump or extractor to a holding tank or strainer.
- Honey stomach (crop)**—a portion of the digestive system in the abdomen of the adult honey bee used for carrying nectar, honey, or water.
- Honey sump**—a clarifying tank between the extractor and honey pump for removing the coarser particles of comb introduced during extraction.
- Increase**—to add to the number of colonies, usually by dividing existing colonies.
- Introducing cage**—small wooden, wire, or plastic cage used to ship/hold queen to introduce/release her to new colony.
- Inner cover**—a lightweight cover used under a standard telescoping cover on a beehive.
- Instrumental (artificial) insemination**—the introduction of drone spermatozoa into the genital organs of a virgin queen by means of special instruments.
- Invertase**—an enzyme produced by honey bees which they add to nectar to break down the sucrose (disaccharide) to glucose and fructose (monosaccharides), the sugars of honey.
- Italian bees**—most widely used population (race) of honey bees in the United States; originated in Italy.
- Langstroth Hive**—our modern-day, man-made home for bees; termed Langstroth for original designer.
- Larva (plural, larvae)**—the second (feeding) stage of bee metamorphosis; a white, legless, grublike insect.
- Laying worker**—a worker that lays infertile eggs, producing only drones, usually in colonies that are hopelessly queenless.
- Levulose**—see “fructose.”
- Mating flight**—the flight taken by a virgin queen while she mates in the air with several drones.
- Mead**—honey wine.
- Migratory beekeeping**—the moving of colonies of bees from one locality to another during a single season to take advantage of two or more honey flows and/or pollination rentals.
- Mite**—see “bee mite.”
- Nectar**—a sweet liquid secreted by the nectaries of plants; the raw product of honey.
- Nectar guide**—color (usually ultraviolet) marks on flowers believed to direct insects to nectar secretion site.
- Nectaries**—the organs of plants that secrete nectar, located within the flower (floral nectaries) or on other portions of the plant (extrafloral nectaries).
- Nosema**—a disease of the adult honey bee caused by the protozoan *Nosema apis*.
- Nuc or Nucleus (plural, nuclei)**—a small hive of bees, usually covering from two to five frames of comb and used primarily for starting new colonies, rearing or storing queens.
- Nurse bees**—young bees, 3 to 10 days old, which feed and take care of developing brood.

- Observation hive**—a small bee colony in a hive made largely of glass or clear plastic sides to permit observation of bees at work.
- Out-apiary (or yard)**—an apiary situated away from the home of the beekeeper.
- Package bees**—a quantity of adult bees (2 to 5 pounds), with or without a queen, contained in a screened shipping cage.
- Paenibacillus larvae***—(formerly *Bacillus larvae*) the bacterium that causes American foulbrood.
- Paralysis**—a virus disease of adult bees that affects their ability to use their legs or wings normally.
- Parthenogenesis**—the development of young from unfertilized eggs. In honey bees the unfertilized eggs produce drones.
- PDB (Paradichlorobenzene)**—crystals used as a fumigant to protect stored drawn combs against wax moth.
- Pheromone**—a chemical secreted by one bee that stimulates behavior in another bee. One well-known bee pheromone is queen substance secreted by the queens.
- Piping**—a series of sounds made by a queen frequently before she emerges from her cell.
- Play (orientation) flight**—short flight taken in front of or near the hive to acquaint young bees with their immediate surroundings; sometimes mistaken for robbing or preparation for swarming.
- Pollen**—the male reproductive cell bodies produced by anthers of flowers, collected and used by honey bees as their source of protein.
- Pollen basket**—a flattened depression located on the outer surface of the bee's hind legs surrounded by curved spines or hairs adapted for carrying pollen gathered from flowers or propolis to the hive.
- Pollen cakes**—moist mixtures of either pollen supplements or substitutes fed to the bees in early spring to stimulate brood rearing.
- Pollen substitute**—a high-protein material such as soybean flour, powdered skim milk, brewer's yeast, or a mixture of these used in place of pollen to stimulate brood rearing.
- Pollen supplement**—a mixture of pollen and pollen substitutes used to stimulate brood rearing in periods of pollen shortage.
- Pollen trap**—a device that is fitted to the colony entrance for removing pollen loads from the pollen baskets of returning bees.
- Pollination**—the transfer of pollen from the anthers to the stigma of flowers.
- Pollinator**—the agent that transfers pollen from an anther to a stigma: bees, flies, beetles, and so forth.
- Pollinizer**—the plant source of pollen used for pollination.
- Prime swarm**—the first swarm to leave the parent colony, usually with the old queen.
- Proboscis**—the mouthparts of the bee that form the sucking tube or tongue.
- Propolis**—sap or resinous materials collected from trees or plants by bees and used to strengthen the comb, close up cracks, and so on; also called bee glue.
- Pupa**—the third stage in the development (metamorphosis) of the honey bee, during which the organs of the larva are replaced by those that will be used by an adult; also termed capped stage as each cell is covered with beeswax.
- Queen**—a fully developed female bee, larger and longer than a worker bee; also called mated queen (a virgin queen is a newly emerged queen who has not yet mated).
- Queen cage**—a small cage in which a queen and three or four worker bees may be confined for shipping and/or introduction into a colony.
- Queenright**—term used to describe a colony with healthy egg-laying queen; opposite is queenless.
- Queen cage candy**—candy made by kneading powdered sugar with invert sugar syrup until it forms a stiff dough; used as food in queen cages.
- Queen cell**—a special elongated cell, resembling a peanut shell, in which the queen is reared. It is usually an inch or more long, has an inside diameter of about  $\frac{1}{3}$  inch, and hangs down from the comb in a vertical position.
- Queen clipping**—removing a portion of one or both front wings of a queen to prevent her from flying.
- Queen cup**—a cup-shaped cell that hangs vertically in a hive and may become a queen cell if an egg or larva is placed in it and bees add wax to it; also commercially available in beeswax or plastic to graft larvae for queen production.



- Queen excluder**—metal or plastic device with spaces that permit the passage of workers but restrict the movement of drones and queens to a specific part of the hive.
- Queen substance**—pheromone material secreted from glands in the queen bee and transmitted throughout the colony by workers to alert other workers of the queen's presence; also stabilizes swarms, attracts drones to virgin queen for mating, and inhibits development of new queen cells.
- Rabbet**—a narrow ledge, often covered with piece of folded metal that is cut into the inside upper end of the hive body from which the frames are suspended.
- Rendering wax**—the process of melting combs and cappings and removing refuse from the wax.
- Requeen**—to replace existing queen with new queen (see "introducing cage") or capped queen cell.
- Robbing**—stealing of nectar, or honey, by bees from other colonies.
- Royal jelly**—a highly nutritious glandular secretion of young bees, used to feed the queen and young brood.
- Sacbrood**—a brood disease of honey bees caused by a virus.
- Scout bees**—worker bees searching for a new source of pollen, nectar, propolis, water, or a new home for a swarm of bees.
- Sealed brood**—see "capped brood."
- Self-pollination**—the transfer of pollen from anther to stigma of the same plant.
- Self-spacing frames**—frames constructed with shouldered end bars so that they are a bee space apart when pushed together in a hive body.
- Skep**—an older, traditional beehive design made of twisted straw without movable frames.
- Slatted rack**—a wooden rack that fits between the bottom board and hive body. This optional piece of hive equipment enables bees to make better use of the lower brood chamber with increased brood rearing, less comb gnawing, and less congestion at the front entrance.
- Slungum**—the refuse from melted comb and cappings after the wax has been rendered or removed.
- Small hive beetle**—a scavenger beetle that is a beehive/honey house pest accidentally introduced into the United States.
- Smoker**—a device in which burlap, wood shavings, or other slow-burning materials are used to produce smoke that is used to subdue bees.
- Solar wax extractor**—a glass-covered insulated box used to melt wax from combs and cappings using the heat of the sun.
- Spermatheca**—a special organ of the queen in which the sperm of the drone is stored.
- Spur embedder**—a device used for mechanically embedding wires into foundation.
- Sting**—the modified ovipositor of a honey bee used to deliver painful venom; used by workers in defense of the hive, by queens to kill rival queens.
- Sucrose**—principal sugar found in nectar.
- Super**—any hive body used for the storage of surplus honey; normally placed over or above the brood chamber.
- Supersedure**—a natural replacement of an established queen by a daughter in the same hive.
- Surplus honey**—honey that exceeds that needed by bees for their own use and can be removed (harvested) for human consumption.
- Swarm**—the aggregate of worker bees, drones, and usually the old queen that leaves the parent colony to establish a new colony. See also "afterswarms."
- Swarming**—the natural method of propagation of the honey bee colony. Also refers to the actual process of bees exiting the hive.
- Swarm cell**—developing queen cell usually found on the bottom of the combs reared by bees before swarming.
- Terramycin**—an antibiotic used to treat European foulbrood. Also used for American foulbrood prevention, but it is not effective in killing the spore stage of this disease.
- Thin super foundation**—a comb foundation used for comb honey or chunk honey production which is thinner than that used for brood rearing.
- Tracheal (acarine) mite**—*Acarapis woodi*, a tiny tracheal infesting honey bee parasite.

**Tylan**—see “tylosin.”

**Tylosin**—an antibiotic used to treat American foulbrood.

**Transferring**—the process of moving bees and combs from non-standard or fixed-comb boxes, bee trees and/or buildings into movable frame hives.

**Travel stain**—the dark discoloration on the surface of comb honey left on the hive for some time, caused by bees tracking propolis over the surface.

**Uncapping knife**—a knife used to shave or remove the cappings from combs of sealed honey prior to extraction; usually heated by steam or electricity.

**Uniting**—combining two or more colonies to form a larger colony.

**Varroa mite**—*Varroa destructor* (formerly *Varroa jacobsoni*), a parasitic mite of adult and pupal stages of honey bees.

**Venom allergy (hypersensitivity)**—a condition in which a person, when stung, may experience a variety of symptoms ranging from extensive swelling, a mild rash or itchiness, to anaphylactic

shock. A person who is stung and experiences abnormal symptoms should consult a physician before working bees again.

**Virgin queen**—an unmated queen.

**Wax glands**—the eight glands that secrete beeswax; located in pairs on the last four visible ventral abdominal segments of worker bees.

**Wax moth**—larvae of the moth *Galleria mellonella*, which seriously damages brood and empty combs. May also refer to other, smaller moths that are also hive pests.

**Wild bee**—a non-*Apis* bee or sometimes a feral colony of honey bees.

**Winter cluster**—a spherical shaped clumping of adult bees within the hive during winter.

**Worker bee**—a female bee whose reproductive organs are undeveloped. Worker bees do all the work in the colony except for laying fertile eggs.

**Worker comb**—comb measuring about five cells to the inch in which workers are reared and honey and pollen are stored.

## Appendix

Much of the information listed here, as well as updates to this information, is also available on our regional Web site: [maarec.cas.psu.edu](http://maarec.cas.psu.edu).

### A. Summary of Current Best Management Practices

Today's leading beekeepers consistently engage in proactive management practices that are profitable while balancing the needs of their bees, the environment, and their customers. These customers include wholesale and retail buyers of hive products, growers of bee pollinated crops, and other beekeepers. We have summarized what we consider to be the current "best management practices" in today's challenging world of beekeeping.

#### 1. Engage in consistent and "hygienic" seasonal management

- Of colonies
  - Maintain strong colonies
  - Develop and implement a swarm prevention strategy
  - Requeen annually with stock that has been selected for characteristics you desire
  - Cull old combs regularly
  - Use chemicals judiciously and responsibly and only when needed
  - Develop a record keeping system that works for you and use it
- Of apiaries
  - Choose apiary locations carefully and with the following in mind: productivity, accessibility, and neighbors (in an urban setting)
  - Remove dead colonies and unused equipment ASAP
  - Deal with diseased colonies immediately and appropriately
  - Discard combs/burr comb, pesticide packaging, or used pesticide strips appropriately, i.e., not in or around the apiary

#### 2. Proactively manage mites, diseases, and other hive maladies

- Be able to identify disease, mites, and other hive maladies
- Routinely monitor for diseases, mites, and other hive maladies
- Develop a foulbrood action plan and be prepared to implement it if colonies should become infected
- Incorporate pest management strategies into routine seasonal management, (for example, mouse guards, bear fences, maintaining strong colonies)
- Implement IPM for the control of mites by using resistant stock and other mite reducing techniques (screen bottom boards, drone sink, and so forth)
- Monitor mite level and treat with chemical controls only when levels exceed an established thresholds

#### 3. Produce a quality product (honey, bees for pollination, nucs, packages, queens, and so on)

- Maintain honey moisture below 17 percent
- Process the honey promptly after removing it from the colonies
- Use only clean equipment and containers when processing and packing honey and other hive products
- Rent only pollination units that exceed the minimum requirements
- Sell nucs, packages, and/or queens that you would be willing to buy yourself

#### 4. Actively market a quality product that you can personally guarantee

- Know your product
- Know your customers
- Sell at a price fair to you and your customer
- Ensure you can supply your market year-round
- Constantly seek ways to add additional value to your product
- Be assertive, persistent, and creative in developing a consistent market

*(Appendix A continued on next page)*

### 5. Stay informed

- Commit yourself as a lifelong learner of honey bee biology and management
- Participate in local, regional, and/or national beekeeping organizations
- Subscribe to one or more beekeeping journals
- Visit and bookmark your favorite beekeeping Web sites
- Read books on beekeeping

### 6. Engage in networking

- Be prepared and willing to offer assistance to others who know less than you
- Be prepared and willing to seek the help of others who know more than you

---

## **B. Apiary Inspection and Extension Services in the Mid-Atlantic**

### **DELAWARE**

#### **Delaware Apiary Inspection**

**Bob Mitchell**

**Jeff Brothers**

DELAWARE DEPT. OF AGRICULTURE  
DIVISION OF PRODUCTION & PROMOTION  
2320 S. DUPONT HIGHWAY  
DOVER, DE 19901  
Tel: 302-739-4811  
Fax: 302-697-6287  
E-mail: Robert.Mitchell@state.de.us

### **MARYLAND**

#### **Maryland Apiary Inspection**

**Jerry Fisher**

MARYLAND DEPT. OF AGRICULTURE  
PLANT PROTECTION SECTION  
50 HARRY S. TRUMAN HWY.  
ANNAPOLIS, MD 21401  
Tel: 410-841-5920  
Fax: 410-841-5835  
E-mail: jerelaf@juno.com

### **NEW JERSEY**

#### **New Jersey Apiary Inspection**

**Paul Raybold**

DIVISION OF PLANT IND.  
P.O. Box 330  
TRENTON, NJ 08625  
Tel: 609-292-5440  
Fax: 609-292-4710  
E-mail: AGPrayB@ag.state.nj.us

### **PENNSYLVANIA**

#### **Pennsylvania Apiary Inspection**

**Dennis VanEnglesdorp**

PA DEPT. OF AGRICULTURE, BUREAU OF PLANT  
INDUSTRY  
2301 NORTH CAMERON STREET  
HARRISBURG, PA 17110-9408  
Tel: 717-787-4843  
E-mail: c-dvanengl@state.pa.us

**WEST VIRGINIA****West Virginia Apiary Inspection**

George Clutter

WEST VIRGINIA DEPT. OF AGRICULTURE

1900 KANAWHA BOULEVARD EAST

CHARLESTOWN, WV 25305

Tel: 304-558-2212

Fax: 304-558-2435

E-mail: gclutter@ag.state.wv.us

**APICULTURE EXTENSION SPECIALISTS:****University of Delaware**

Dewey M. Caron

DEPARTMENT OF ENTOMOLOGY &amp; APPLIED ECOLOGY

250 TNS

UNIVERSITY OF DELAWARE

NEWARK, DE 19717

Tel: 302-831-8333

Fax: 302-831-8889

E-mail: Dmcaron@udel.edu

Web site: udel.edu/dmcaron/

**University of Maryland**

Mike Embrey

WYE RES &amp; EDUC CENTER

P.O. BOX 169

QUEENSTOWN, MD 21658

Tel: 410-827-8056

Fax: 410-827-9039

E-mail: Me15@umail.umd.edu

**The Pennsylvania State University**

Maryann Frazier

THE PENNSYLVANIA STATE UNIVERSITY

DEPARTMENT OF ENTOMOLOGY

501 ASI BUILDING

UNIVERSITY PARK, PA 16802

Tel: 814-865-4621

E-mail: mxt15@psu.edu

**C. Chemicals Approved for Legal Use in Honey Bee Colonies**

All pesticides listed here are registered for use in honey bee colonies as of January 2004. If any material listed should lose or change its registration, or if new materials become available, a notice will be posted on the MAAREC Web site at: maarec.cas.psu.edu. If you do not have access to the Internet and are unsure about the registration status of a pesticide or chemical, contact your state apiary inspector or your extension specialist for the most up-to-date information on materials registered for use in honey bee colonies. **It is illegal to use unregistered materials in honey bee colonies. Use only registered materials and follow label directions at all times!**

**AMERICAN FOULBROOD****oxytetracycline\*****Terramycin®**

Soluble Powder is used for the prevention (and sometimes the treatment) of European and American foulbrood. This product is available from farm supply stores in a 6.4 oz packet. The package directions can be confusing. The following information should help you determine the correct application amounts:

- The legal dose is 200 mg, three times, at 4–5 day intervals
- A package has 10 grams (10,000 mg) of Terramycin
- $10,000 \text{ mg} / 200 = 50$  treatments per package
- $50 \text{ treatments} / 3 = 17$
- Therefore, one 6.4 oz package treats 17 colonies three times

The package calls for one teaspoon Terramycin Soluble Powder per ounce of powdered sugar.

Use the following calculations:

- Each level teaspoon of Terramycin equals 200 mg or one treatment.
- Each 6.4 oz package contains 50 treatments, so mix one package with 50 oz (just over 3 lbs.) of powdered sugar. Store in a tightly sealed container (exposure to air and moisture will break down Terramycin).
- The dosage per colony is 2 tablespoons of this mixture, given 3 times (600 mg total per colony), 4–5 days apart. Spread two tablespoons of the Terramycin mixture over the end of the top bars in the hive body with the most brood in it.

Treat colonies in the fall after your honey supers are off and again in the spring 45 days before you put your honey supers on.

**Pre-mixed Terramycin formulations:**

- Terra Brood Mix*® (Mid-Con)
- Tetra BeeMix*® (Dadant)
- Terra Patties*® (Mann Lake)
- Terra Pro*® (Mann Lake)

**Terra Brood Mix and Tetra Bee Mix**

This are pre-mixed Terramycin products used in the prevention of American and European foulbrood. It takes the guesswork out of how much Terramycin and sugar to mix together. With both products the dosage is 2 tablespoons, 3 times, 4–5 days apart. Spread two tablespoons of the Terramycin mixture over the end of the top bars in the hive body with the most brood in it. Colonies should be treated in the fall after your honey supers are off and again in the spring at least 45 days before you put your honey supers on.

**Tylosin titrate**

**Tylan® (Elanco, a division of Eli Lilly and Co.)**

This prescription drug should be used on honey bee colonies only after obtaining a prescription from a veterinarian. In addition, it can only be used on colonies with an active case of AFB, and therefore cannot be used as a preventative treatment.

- The material is mixed with powdered sugar and applied by dusting.
- The legal dose is 200 mg of Tylan® mixed with 20 grams of powdered sugar. This dose is applied three times at 7-day intervals.
- To prepare one dose (single application) mix 1/8 teaspoon with 2 tablespoons. Apply three doses at 7-day intervals.
- The material comes in 100g bottles. To mix an entire bottle, combine one 100g bottle with 22 lbs. pounds of powdered sugar. Apply three treatments of 2 tablespoons at 7-day intervals.

**EUROPEAN FOULBROOD**

**oxytetracycline\***

**Terramycin®**

Follow the directions for application as describe above in American foulbrood.

**NOSEMA**

**fumagillin\***

**Fumidil-B® (Mid-Con)**

- The dosage is 1 teaspoon of Fumidil-B per gallon of syrup. Fumidil-B is available in 3 sizes.
- 0.5 gm—makes 5–6 gallons of medicated syrup (follow mixing instructions below)
- 2 gm—20–24 gallons
- 9.5 gm—100–120 gallons

Fall treatment is 2 gallons of medicated syrup per hive given after the honey supers have been removed. The spring treatment is 1 gallon medicated syrup per hive given at least 30 days prior to the honey flow.

**Mixing instructions:** Fumidil-B mixes best when added to warm water. Use 4 ounces of water per teaspoon of Fumidil-B, let it set for a few minutes until the water is absorbed, shake it, then add it to 1 gallon of prepared syrup. For a larger quantity, (the 9.5 gm jar), use approximately 1 gallon of warm water, add to 100–120 gallons of prepared syrup.

**VARROA MITES**

**fluvalinate\***

**Apistan Strips® (Zoecon)**

**Apistan Queen Tabs® (Zoecon)**

**Apistan Strips**

- Wear rubber dish washing or chemical gloves when handling strips.
- Do not treat colonies with surplus honey supers if the honey is to be used for human consumption.
- Use one strip for each five frames of bees (deep frames or the equivalent).
- Treat all colonies within the yard at the same time; treatment is most effective when brood rearing is lowest.
- Leave the treatment in the colony for *at least* 42 days but not more than 45.

**coumaphos\***

**Check Mite+®—(Mann Lake) section 18 only; emergency use registration**

- Wear rubber dish washing or chemical gloves when handling strips.
- Do not treat colonies with surplus honey supers if the honey is to be used for human consumption.
- Use one strip for each five frames of bees (deep frames or the equivalent).
- Treat all colonies within the yard at the same time; treatment is most effective when brood rearing lowest.

- Leave the treatment in the colony for *at least* 42 days but not more than 45.
- Do not treat more twice per year for varroa.

#### essential oils

##### **Api-Life Var® (Brushy Mountain Bee Farm) emergency use registration in some states**

This product is the essential oil miticide, which is manufactured in Italy and has been used in Europe for several years. Brushy Mountain Bee Farm, phone: 800-233-7929, is the sole vendor of the product in the United States. Tests in several southern states have shown it to be effective against varroa mites. Api-Life Var® product consists of wafers of vermiculite (a substance used in floral arrangements) impregnated with the naturally occurring oils: thymol, eucalyptol, camphor, and menthol. To avoid skin irritation, wear waterproof gloves when handling Api-Life Var®. To prevent bee mortality while ensuring effective mite kill, follow label directions precisely; specifically, treatment should occur when average daily temperatures are between 59 and 69°F (15 to 21°C) and should not occur when temperatures are above 90°F (32°C). This miticide can only be used in late summer or fall, as there must be a 5-month (150-day) period between the end of treatment and supering colonies for honey collection.

#### TRACHEAL MITES

##### menthol\*

##### **Mite-A-Thol® (Mann Lake)**

- Remove all surplus honey and empty supers. Honey for bee food may remain.
- Menthol treatment is 50 grams or  $\frac{1}{3}$  cup of menthol pellets or crystals, in a 7 x 7 inch screen packet.
- Place the menthol packet on the top bars immediately above the broodnest and below any winter stores. Position the packet in a back corner of the hive so it is not directly above a lot of brood. If the daily temperatures are above 80°F (26°C) for more than a day or two, place menthol in a back corner of the bottom board to avoid driving the bees out of the hive.
- Menthol requires warm temperatures to vaporize and kill mites. The label says to apply treatment when temperatures reach at least 60°F (15°C). However, research at Penn State showed that daytime high temperatures above 70°F (21°C) for

at least 7 consecutive days are required for good treatment.

- The recommended treatment period is 30 to 45 days.

#### **VARROA TREATMENT WITH FORMIC ACID GEL**

Formic acid gel is registered in the United States for the control of tracheal (varroa) mites. However, problems with the packaging of this material have occurred, which has delayed its availability to beekeepers. Formic acid gel packs are applied to the top bars of the colony in late summer or early fall; one gel pack per colony. Formic acid works as a fumigant (vapor) and must evaporate from the packs to kill mites; this requires warm daytime temperatures and proximity to the heat from the bee cluster. The gel in the pack slows down and evens out the evaporation of the formic acid, making only one application necessary for a 3-week treatment. Always read and follow all label instructions. Wear chemical-resistant gloves during applications and removals and use extreme care in handling this material; formic acid is a strong acid that may cause burns to skin or upon inhalation.

#### **WAX MOTHS**

##### paradichlorobenzene\*

##### **Fumigator® (Dadant)**

##### **Para-moth® (Mann Lake)**

#### **SMALL HIVE BEETLES**

##### coumaphos\*

##### **Check Mite+®—(Mann Lake)—section 18 only; emergency use registration**

- Wear rubber dish washing gloves when handling strips.
- Do not treat colonies with surplus honey supers if the honey is to be used for human consumption.
- Prepare a piece of corrugated cardboard about 6 x 6 inches by removing the paper from one side. Cut the Bayer Bee Strip in half and staple both pieces to the corrugated side of the cardboard. The cardboard should then be placed in the center of the bottom board with the strips facing down.
- The treatment should remain on the colony for at least 3 days but no more than 7 days.

\* Active ingredients

Names in ( ) are the companies that hold the registration for each material.

## D. Sources of Information and Assistance for Beekeepers

Many of the publications listed here are available on the MAAREC Web site: [maarec.cas.psu.edu](http://maarec.cas.psu.edu).

### ORGANIZATIONS

#### State

Each of the Mid-Atlantic States, as well as most other states, has an active state beekeeping association. For current contact information on these associations, consult the MAAREC Web site or your local cooperative extension office.

#### National

AMERICAN BEEKEEPING FEDERATION, INC.  
PO Box 1038  
JESSUP, GA 31545  
Tel: 912-427-8447  
Web site: [www.abfnet.org](http://www.abfnet.org)

AMERICAN HONEY PRODUCERS ASSOC.  
Web site: [www.americanhoneyproducers.org](http://www.americanhoneyproducers.org)

NATIONAL HONEY BOARD  
421 21ST AVE. #203  
LONGMONT, CO 80501-1421  
Tel: 303-776-2337  
Fax: 303-776-1177  
Web site: [www.nhb.org](http://www.nhb.org)

#### Regional

EASTERN APICULTURAL SOCIETY  
LORETTA SUPRENANT, SECRETARY  
Box 300A  
COUNTY HOME RD.  
ESSEX, NY 12936  
Tel: 518-963-7593 (home)

### BEEKEEPING JOURNALS AND PERIODICALS

*American Bee Journal*  
DADANT & SONS, INC.  
HAMILTON, IL 62341  
Tel: 217-847-3324  
Fax: 217-847-3660

#### *Bee Culture*

A.I. ROOT CO.  
623 W. LIBERTY ST.  
MEDINA, OH 44256  
Tel: 1-800-289-7668 ext. 3220  
Fax: 216-725-5624  
E-mail: [beeculture@aol.com](mailto:beeculture@aol.com)

#### *The Speedy Bee*

THE SPEEDY BEE  
P.O. Box 998  
JESUP, GA 31545-0998  
Tel: 912-427-4018  
Fax: 912-427-8447

#### *Bee World, Journal of Apicultural Research Apicultural Abstracts*

INTERNATIONAL BEE RESEARCH ASSOCIATION (IBRA)  
18 NORTH ROAD  
CARDIFF, CF1 3D4 UNITED KINGDOM  
Telephone: 0222-372409  
Fax: 0222-665522

### EXTENSION PUBLICATIONS

#### Mid-Atlantic Regional Bulletins

New topics are added regularly, so check the MAAREC Web site for an up-to-date listing.

#### General

- Bees Are Beneficial
- Information for Bee-Ginners
- What Is the Africanized Honey Bee?
- Honey Bee Biology

#### Starting with Bees

- Tips on How to Handle Bees
- Beekeeping Equipment & Supplies
- Queen & Package Bee Suppliers
- Sources of Information/ Assistance for Beekeepers
- Agricultural Alternatives—Beekeeping
- Beekeeping for Beginners
- Keeping Bees in Populated Areas/Tips for Suburban Beekeepers



**Bee Management**

- Early Spring Management
- Fall Management
- Dividing Honey Bee Colonies
- Swarming
- Transferring Bees
- Removing Bees
- Bait Hives
- Honey
- Beeswax

**Diseases/Pests**

- What Is the Africanized Honey Bee?
- Tracheal Mites
- Pests of Honey Bees
- Stinging Insect Control
- Wax Moth
- Small Hive Beetle
- Varroa Mite
- Integrated Pest Management (IPM) for Beekeepers
- Diseases of Honey Bees
- Bears

**Pollination**

- Hives for Hire
- Pollination
- Moving Bees
- Pollination Contracts

**Publications available from the cooperative extension service, USDA:**

DR. JAMES E. TEW  
NATIONAL PROGRAM LEADER, APICULTURE  
THE OHIO STATE UNIVERSITY  
1328 DOVER ROAD  
WOOSTER, OH 44691.

- *The Thermology of Wintering Honey Bee Colonies*. 1971. Technical Bulletin #1429. \$2.00
- *Electric Heating of Honey Bee Hives*. 1967. Technical Bulletin #1377. \$2.00
- *Shade and Water for the Honey Bee Colony*. 1975. Leaflet #530. \$2.00
- *Beekeeping for Beginners*. 1979. Leaflet—Home and Garden #158. \$2.00

- *A Small-Scale Agriculture Alternative*. 1990. Unnumbered leaflet. Free
- *Honey Bees in Buildings*. 1988. Fact Sheet 2079-88. Free
- *Beekeeping in the United States*. 1980. Agriculture Handbook #335
- *Africanized Honey Bees—Selected Topics*. 1991. Fact Sheets.

A complete listing of national and state cooperative extension service beekeeping publications (National Beekeeping Publications List) is also available at the above address.

**COMPUTER SOFTWARE**

*BeeAware 2000* is a CD-ROM (for Windows) packed with information on honey bee management, accompanied by hundreds of high-quality images and illustrations. For additional information or to order, contact the Penn State Department of Entomology, 501 ASI Building, University Park, PA 16802. Phone 814-865-1895. \$50.00.

**AUDIO VISUAL MATERIALS**

*Varroa Mites: Life Cycle, Detection and Control*. 1999. A 16-minute video describing the details of the varroa mite biology and control. Available from Information and Communication Technologies, 119 Ag Administration Bldg., University Park, PA 16802. Phone 814-865-6309. \$25.00

*Why Honey Bees?* 1993. Video for the public on the importance of honey bees and the current challenges beekeepers face. Available from Information and Communication Technologies, 119 Ag Administration Bldg., University Park, PA 16802. Phone 814-865-6309. \$35.00.

*Honey Bee Diseases*. 1998. Slide set of 53 slides and a detailed script on identification and control of honey bee diseases. Available from the Penn State Department of Entomology, 501 ASI Building, University Park, PA 16802. Phone 814-865-1895. \$60.00.

*Honey Bee Parasites, Pests and Predators*. 1998. Slide set of 67 slides and a detailed script on the identification and control of honey bee parasites, pests, and predators. Available from the Penn State Department of Entomology, 501 ASI Building, University Park, PA 16802. Phone 814-865-1895. \$60.00.

**BOOKS**

Aebi, Ormond, and Harry. 1983. *The Art and Adventure of Beekeeping*. Rodale Press, Emmaus, PA. 184 pp.

Bailey, L., and B. V. Ball. 1991. *Honey Bee Pathology*, 2nd edition. Academic Press, San Diego, CA. 193 pp.

Berthold, R. Jr. 1993. *Beeswax Crafting*. Wicwas Press, Cheshire, CT. 125 pp.

Bonney, Richard E. 1993. *Beekeeping: A Practical Guide*. Storey Communications, Pownal, VT. 184 pp.

Bonney, Richard E. 1991. *Hive Management: A Seasonal Guide For Beekeepers*. Storey Communications, Pownal, VT. 160 pp.

Butler, Colin G. 1976. *The World of the Honeybee* (revised edition). Collins Press, London. 226 pp.

Caron, Dewey M. 1999. *Honey Bee Biology and Beekeeping*. Wicwas Press, LLC, Cheshire, CT. 355 pp. or directly from the author

Caron, Dewey M. 2001. *Africanized Honey Bees in the Americas*. A. I. Root Co., Medina, OH. 228 pp. or directly from the author.

Cogshall, William L. and Roger A. Morse. 1984. *Beeswax: Production, Harvesting, Processing and Products*. Wicwas Press, Cheshire, CT. 196 pp.

Crane, Eva. 1980. *A Book of Honey*. Charles Scribner's Sons, New York, NY. 193 pp.

Collison, Clarence. 2002. *What Do You Know?* A. I. Root Co., Medina, OH. 430pp.

Crane, Eva. 1983. *The Archaeology of Beekeeping*. Cornell University Press, Ithaca, NY. 360 pp.

Dadant & Sons, editors. 1978. *Beekeeping Questions and Answers*. Dadant & Sons, Inc., Hamilton, IL. 256 pp.

Dadant & Sons, editors. 1980. *The Honey Kitchen*. Dadant & Sons, Inc., Hamilton, IL. 208 pp.

Dadant, C. P. 1980. *First Lessons in Beekeeping*. Scribner, New York, NY. 127 pp.

Delaplane, Keith S. 1993. *Honey Bees & Beekeeping: A Year in the Life of an Apiary*. University of Georgia Extension. 138 pp.

Delaplane, Keith S., and Thomas C. Webster, editors. 2001. *Mites of the Honey Bee*. Dadant and Sons, Inc., Hamilton, IL 280 pp

Free, John. 1993. *Insect Pollination of Crops*. 2nd edition. Academic Press, San Diego, CA. 684 pp.

Goltz, Lawrence R. 1977. *Honey Plants Manual*. A. I. Root Co., Medina, OH. 96 pp.

Graham, J. M., Editor 1992. *The Hive and the Honey Bee*. Dadant & Sons, Inc., Hamilton, IL. 1324 pp.

Hansen, Henrik, and Roger A. Morse. 1981. *Honey Bee Brood Diseases*. Wicwas Press, Cheshire, CT. 30 pp.

Hepburn, H. R. 1986. *Honeybees and Wax*. Springer-Verlag, New York, NY. 215 pp.

Johansen, Carl, and Mayer, Dan. 1990. *Pollinator Protection: A Bee and Pesticide Handbook*. Wicwas Press, Cheshire, CT . 212 pp.

Killion, Eugene E. 1981. *Honey in the Comb*. Dadant & Sons, Inc., Hamilton, IL. 148 pp.

Laidlaw, Harry H. Jr., 1977. *Instrumental Insemination of Honey Bee Queens*. Dadant & Sons, Inc., Hamilton, IL. 144 pp.

Laidlaw, Harry H. Jr., and Robert E. Page Jr. 1997. *Queen Rearing and Bee Breeding*. Wicwas Press, Cheshire, CT. 224 pp.

Loring, Murray. 1981. *Bees and the Law*. Dadant & Sons, Inc., Hamilton, IL. 128 pp.

Matheson, Andrew. 1993. *Living with Varroa*. Cardiff: International Bee Research Association, London. 58 pp.

Morse, Roger A. 1975. *Bees and Beekeeping*. Cornell University Press, Cheshire, CT. 320 pp.

Morse, Roger A. 1994. *Raising Queen Honey Bees* (Second edition). Wicwas Press, Chester, CT. 128 pp.

Morse, Roger A. 1992. *Making Mead*. Wicwas Press, Ithaca, NY. 128 pp.

Morse, Roger A. 1983. *A Year in the Beeyard*. Wicwas Press, Ithaca, NY. 166 pp.

Morse, R., and R. Flottum. 1990. *ABC and XYZ of Bee Culture: An Encyclopedia of Beekeeping*. A. I. Root Co., Medina, OH. 528 pp. soon to be revised

National Honey Board. 1994. *Sweetened with Honey the Natural Way*. 96 pp.

Riches, H. R. C. 1989. *Honey Marketing*. Burrowbridge: Bee Books New & Old. 80 pp.

Root, A. I., et al, editors. 1988. *The New Starting Right With Bees: A Beginner's Handbook on Beekeeping*. A.I. Root Co., Medina, OH. 137 pp.

Root, A. I. Co. 1978, editors. *500 Answers to Bee Questions*. A. I. Root Co., Medina, OH. 95 pp.

Sammataro, Diana, and Alphonse Avitabile. *The Beekeepers Handbook*. 1998. Cornell University Press. 190 pp.

Spivak, M., D. J. C. Fletcher, and M. D. Breed (eds.). 1991. *The "African" Honeybee*. Westview, Boulder, CO. 435 pp.

Taylor, Richard. 1980. *How-To-Do-It Book of Beekeeping*. Linden Books, Interlaken, NY. 252 pp.

von Frisch, Karl. 1966. *The Dancing Bees*. Harcourt Brace Jovanovich, Inc., New York, NY. 198 pp.

von Frisch, Karl. 1967. *The Dance Language and Orientation of Bees*. Belknap Press, Harvard University, Cambridge, MA. 566 pp.

von Frisch, Karl. 1971. *Bees: Their Vision, Chemical Senses and Language*. Cornell University Press, Ithaca, NY. 157 pp.

Winston, Mark L. 1991. *The Biology of the Honeybee*. Harvard University Press. 296 pp.

#### VIDEOS AVAILABLE ON HONEY BEES

A large number of videos (VHS tapes and 16 mm films) are available on topics related to honey bees and beekeeping, though some are no longer widely available. Sources for purchase of videos in the Mid-Atlantic area include the A. I. Root Co., Brushy Mountain Bee Supply, Dadant & Sons Inc., and Draper's Super Bee Apiaries. Rentals of some new and older titles are available from Penn State's MediaTech and can be acquired through the cooperative extension service. Some local and state bee associations may also have libraries of audiovisual materials.

A. I. ROOT COMPANY (PUBLICATIONS)  
MEDINA, OH 44256  
Phone: 330-725-6677; 800-289-7668  
Fax: 330-725-5624  
E-mail: beeculture@airoot.com  
Web site: www.beeculture.com

BRUSHY MOUNTAIN BEE FARM  
610 BETHANY CHURCH RD.  
MORAVIAN FALLS, NC 28654  
Phone: 336-921-3640  
Fax: 336-921-2681  
Web site: www.beeequipment.com

DADANT & SONS INC.  
51 SOUTH 2ND  
HAMILTON, ILLINOIS 62341  
Phone: 217-847-3324  
Fax: 217-847-3660  
Order line: 888-922-1293  
E-mail: Dadant@dadant.com  
Web site: www.dadant.com

DRAPER'S SUPER BEE APIARIES  
HUDSON HILL ROAD  
RR 1, Box 97  
MILLERTON, PA 16936  
Phone: 800-233-4273  
Fax: 570-537-2727  
E-mail: sales@draperbee.com  
Web site: www.draperbee.com

PENN STATE MEDIATECH  
SPECIAL SERVICES BUILDING  
151 STANDING STONE LANE  
STATE COLLEGE, PA 16803-1886  
Phone: 800-826-0132; 814-865-6314; 814-863-3202  
Web site: www.libraries.psu.edu/mtss/catalog.html

## E. Beekeeping Supply Companies

A. I. ROOT COMPANY  
MEDINA, OH 44256  
Phone: 216-725-6677; 800-289-7668  
Fax: 216-725-5624  
Supplies and publications  
E-mail: beeculture@airoot.com  
Web site: www.airoot.com

BETTERBEE, INC.  
R.R. #4, Box 4070  
GREENWICH, NY 12834  
Inquiries: 518-692-0221  
Orders: 1-800-632-3379  
Fax: 518-692-9669  
Supplies: queens, nucs, packages available  
(Wilbanks, supplier)  
E-mail: betterbee@betterbee.com  
Web site: betterbee.nycap.rr.com

BRUSHY MTN. BEE FARM  
610 BETHANY CHURCH RD.  
MORAVIAN FALLS, NC 28654  
Phone: 336-921-3640  
Fax: 336-921-2681  
Woodenware, supplies  
Web site: www.beeequipment.com

DADANT & SONS, INC.  
51 S. 2ND ST.  
HAMILTON, IL 62341  
Phone: 217-847-3324  
Toll free order line: 1-800-637-7468  
Fax: 217-847-3660  
Woodenware, supplies, extracting equipment  
E-mail: dadant@dadant.com

DRAPER'S SUPER BEE APIARIES  
HUDSON HILL ROAD  
RR 1, Box 97  
MILLERTON, PA 16936  
Phone: 800-233-4273  
Fax: 570-537-2727  
E-mail: sales@draperbee.com  
Web site: www.draperbee.com

ENIM CO.  
1382 HAMMEL RD.  
EAGLE POINT, OR 97524  
Phone: 541-826-8227  
Wooden bee frames  
E-mail: enim@internetcds.com

MANN LAKE SUPPLY  
COUNTY RD. 40 & FIRST ST.  
HACKENSACK, MN 56452  
Phone: 218-675-6688  
Orders: 1-800-233-6663  
Fax: 218-675-6156  
Supplies: woodenware  
E-mail: beekeepr@mannlakeltd.com  
Web site: www.mannlakeltd.com

MAXANT INDUSTRIES  
PO Box 454  
28 HARVARD RD.  
AYER, MA 01432  
Phone: 978-772-0576  
Fax: 978-772-6365  
Equipment

WALTER T. KELLY CO., INC.  
3107 ELIZABETHTOWN RD.  
PO Box 240  
CLARKSON, KY 42726-0240  
PHONE: 502-242-2012  
FAX: 502-242-4801  
Manufactures supplies: queens, packages,  
woodenware



Emerging worker bee. (Courtesy Maryann Frazier)



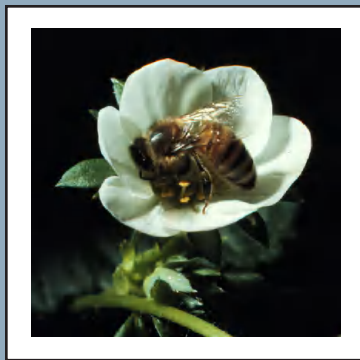

---

Visit Penn State's College of Agricultural Sciences on the Web: [www.cas.psu.edu](http://www.cas.psu.edu)

Penn State College of Agricultural Sciences research, extension, and resident education programs are funded in part by Pennsylvania counties, the Commonwealth of Pennsylvania, and the U.S. Department of Agriculture.

This publication is available from the Publications Distribution Center, The Pennsylvania State University, 112 Agricultural Administration Building, University Park, PA 16802. For information telephone 814-865-6713.

Where trade names appear, no discrimination is intended, and no endorsement by Penn State Cooperative Extension is implied.

This publication is available in alternative media on request.

The Pennsylvania State University is committed to the policy that all persons shall have equal access to programs, facilities, admission, and employment without regard to personal characteristics not related to ability, performance, or qualifications as determined by University policy or by state or federal authorities. It is the policy of the University to maintain an academic and work environment free of discrimination, including harassment. The Pennsylvania State University prohibits discrimination and harassment against any person because of age, ancestry, color, disability or handicap, national origin, race, religious creed, sex, sexual orientation, gender identity, or veteran status. Discrimination or harassment against faculty, staff, or students will not be tolerated at The Pennsylvania State University. Direct all inquiries regarding the nondiscrimination policy to the Affirmative Action Director, The Pennsylvania State University, 328 Boucke Building, University Park, PA 16802-5901, Tel 814-865-4700/V, 814-863-1150/TTY.

© The Pennsylvania State University 2004

Produced by Information and Communication Technologies in the College of Agricultural Sciences

Code # **AGRS-93**

R3M4/07mpc4632